

# **sysmocom**

sysmocom - s.f.m.c. GmbH



## **OsmoBTS User Manual**

by Harald Welte

Copyright © 2016-2021 sysmocom - s.f.m.c. GmbH

Permission is granted to copy, distribute and/or modify this document under the terms of the GNU Free Documentation License, Version 1.3 or any later version published by the Free Software Foundation; with the Invariant Sections being just 'Foreword', 'Acknowledgements' and 'Preface', with no Front-Cover Texts, and no Back-Cover Texts. A copy of the license is included in the section entitled "GNU Free Documentation License".

HISTORY			
NUMBER	DATE	DESCRIPTION	NAME
1.7.1	2023-May-29		HW

# Contents

<b>1</b>	<b>Foreword</b>	<b>1</b>
1.1	Acknowledgements	1
1.2	Endorsements	2
<b>2</b>	<b>Preface</b>	<b>2</b>
2.1	FOSS lives by contribution!	2
2.2	Osmocom and sysmocom	3
2.3	Corrections	3
2.4	Legal disclaimers	3
2.4.1	Spectrum License	3
2.4.2	Software License	3
2.4.3	Trademarks	3
2.4.4	Liability	4
2.4.5	Documentation License	4
<b>3</b>	<b>Introduction</b>	<b>4</b>
3.1	Required Skills	4
3.2	Getting assistance	5
<b>4</b>	<b>Overview</b>	<b>5</b>
4.1	About this manual	5
4.2	About OsmoBTS	5
4.3	Credits	5
4.4	OsmoBTS in the Osmocom GSM network architecture	5
<b>5</b>	<b>Abis/IP Interface</b>	<b>6</b>
5.1	A-bis Operation & Maintenance Link	6
5.2	A-bis Radio Signalling Link	6
5.3	Locate Abis/IP based BTS	7
5.3.1	abisip-find	7
5.4	Deploying a new nanoBTS	7
5.4.1	ipaccess-config	7
<b>6</b>	<b>OsmoBTS Interfaces</b>	<b>8</b>
6.1	OsmoBTS Abis/IP Interface	8
6.2	bts_model specific PHY interface	9
6.3	OsmoBTS VTY Interface	9
6.4	OsmoBTS Control Interface	9
6.4.1	trx.N.thermal-attenuation	9
6.5	OsmoBTS GSMTAP Interface	9
6.6	OsmoBTS PCU Socket Interface	10

<b>7</b>	<b>Control interface</b>	<b>10</b>
7.1	thermal-attenuation	10
<b>8</b>	<b>Osmocom Counters</b>	<b>11</b>
8.1	Osmo Counters (deprecated)	11
8.2	Rate Counters	11
8.3	Stat Item	11
8.4	Statistic Levels	11
8.4.1	Global	11
8.4.2	Peer	12
8.4.3	Subscriber	12
8.5	Stats Reporter	12
8.5.1	Configuring a stats reporter	12
8.6	Socket stats	13
8.6.1	Configuration	13
8.6.2	Generated stats items	13
<b>9</b>	<b>Counters</b>	<b>14</b>
9.1	Rate Counters	14
<b>10</b>	<b>Osmo Stat Items</b>	<b>15</b>
<b>11</b>	<b>Osmo Counters</b>	<b>15</b>
<b>12</b>	<b>The Osmocom VTY Interface</b>	<b>15</b>
12.1	Accessing the telnet VTY	16
12.2	VTY Nodes	17
12.3	Interactive help	17
12.3.1	The question-mark (?) command	17
12.3.2	TAB completion	18
12.3.3	The list command	19
12.3.4	The attribute system	21
12.3.5	The expert mode	22
<b>13</b>	<b>libosmocore Logging System</b>	<b>23</b>
13.1	Log categories	23
13.2	Log levels	23
13.3	Log printing options	24
13.4	Log filters	24
13.5	Log targets	24
13.5.1	Logging to the VTY	25

13.5.2	Logging to the ring buffer	25
13.5.3	Logging via gsmmap	25
13.5.4	Logging to a file	26
13.5.5	Logging to syslog	27
13.5.6	Logging to systemd-journal	27
13.5.7	Logging to stderr	29
<b>14</b>	<b>BTS Configuration</b>	<b>29</b>
14.1	Command Line Options	29
14.1.1	SYNOPSIS	29
14.1.2	OPTIONS	29
14.2	Configuration using the VTY	30
14.2.1	Required BTS/TRX configuration	30
14.2.2	Configuring GSMTAP tracing	31
14.2.3	Configuring power ramping	32
14.2.4	Running multiple instances	32
<b>15</b>	<b>Support for Dynamic Timeslots (TCH/F, TCH/H, PDCH)</b>	<b>32</b>
<b>16</b>	<b>OsmoBTS hardware support</b>	<b>33</b>
<b>17</b>	<b>osmo-bts-sysmo for sysmocom sysmoBTS</b>	<b>33</b>
17.1	osmo-bts-sysmo specific command line arguments	34
17.2	osmo-bts-sysmo specific VTY commands	34
17.2.1	at the <i>SHOW</i> node	34
17.2.1.1	show trx 0 clock-source	34
17.2.1.2	show trx 0 dsp-trace-flags	34
17.2.1.3	trx 0 dsp-trace-flag	34
17.2.2	at the <i>ENABLE</i> node	34
17.2.2.1	trx 0 tx-power <-110-100>	34
17.2.2.2	trx 0 rf-clock-info reset	34
17.2.2.3	trx 0 rf-clock-info correct	34
17.2.3	at the <i>PHY instance</i> node	34
17.2.4	clock-calibration eeprom	34
17.2.5	clock-calibration default	35
17.2.6	clock-calibration <-4095-4095>	35
17.2.7	clock-source (tcxo ocxo ext gps)	35
17.2.8	trx-calibration-path PATH	35
17.3	osmo-bts-sysmo specific control interface commands	35
17.3.1	trx.0.clock-info	35
17.3.2	trx.0.clock-correction	36

<b>18 osmo-bts-trx for OsmoTRX</b>	<b>36</b>
18.1 osmo-bts-trx specific VTY commands	36
18.1.1 at the <i>SHOW</i> node	36
18.1.1.1 show transceivers	36
18.1.2 at the <i>PHY</i> configuration node	36
18.1.2.1 osmotrx ip HOST	36
18.1.2.2 osmotrx ip (local remote) A.B.C.D	36
18.1.2.3 osmotrx base-port (local remote) <0-65535>	37
18.1.2.4 osmotrx fn-advance <0-30>	37
18.1.2.5 osmotrx rts-advance <0-30>	37
18.1.2.6 osmotrx rx-gain <0-50>	37
18.1.2.7 osmotrx tx-attenuation <0-50>	37
18.1.2.8 osmotrx tx-attenuation oml	37
18.1.3 at the <i>PHY Instance</i> configuration node	38
18.1.3.1 slotmask (1 0) (1 0) (1 0) (1 0) (1 0) (1 0) (1 0) (1 0)	38
18.1.3.2 osmotrx maxdly <0-31>	38
<b>19 osmo-bts-octphy for Octasic OCTPHY-2G</b>	<b>38</b>
<b>20 osmo-bts-litecell1115 for Nutaq/Nuran LiteCell 1.5</b>	<b>38</b>
20.1 osmo-bts-trx specific VTY commands	38
20.1.1 at the <i>SHOW</i> node	38
20.1.1.1 show phy <0-255> system-information	38
20.1.1.2 show phy <0-255> rf-port-stats <0-1>	39
20.1.1.3 show phy <0-255> clk-sync-stats	39
20.1.2 at the <i>PHY</i> configuration node	39
20.1.2.1 octphy hw-addr HWADDR	39
20.1.2.2 octphy net-device NAME	39
20.1.2.3 octphy rf-port-index <0-255>	39
20.1.2.4 octphy rx-gain <0-73>	39
20.1.2.5 octphy tx-attenuation <0-359>	39
<b>21 osmo-bts-virtual for Virtual Um Interface</b>	<b>39</b>
21.1 osmo-bts-virtual specific VTY commands	40
21.1.1 at the <i>PHY</i> config node	40
21.1.1.1 virtual-um net-device NETDEV	40
21.1.1.2 virtual-um ms-udp-port <0-65535>	40
21.1.1.3 virtual-um ms-multicast-group GROUP	40
21.1.1.4 virtual-um bts-udp-port <0-65535>	40
21.1.1.5 virtual-um bts-multicast-group GROUP	40

<b>22 OsmoBTS software architecture</b>	<b>40</b>
22.1 OsmoBTS PHY interface abstraction	40
22.1.1 PHY link	40
22.1.2 PHY instance	41
22.1.3 Mapping PHY instances to TRXs	41
22.2 Internal control flow	41
22.2.1 start-up / sequencing during OsmoBTS start	41
22.2.2 At time of OML establishment	42
22.2.3 At time of RSL connection loss	42
<b>23 Osmux</b>	<b>42</b>
23.1 Osmux and NAT	42
23.2 CID allocation	43
23.3 3GPP AoIP network setup with Osmux	44
23.4 SCCPLite network setup with Osmux	46
23.5 SCCPLite network setup with Osmux + BSC-NAT	48
23.6 Osmux and MGCP	50
23.6.1 X-Osmux Format	50
23.6.2 X-Osmux Considerations	50
23.6.3 X-Osmux Support	51
23.7 Abis setup with Osmux	51
23.8 Osmux Support in OsmoBTS	52
<b>24 QoS, DSCP/TOS, Priority and IEEE 802.1q PCP</b>	<b>53</b>
24.1 IP Level (DSCP)	53
24.2 Packet Priority	53
24.3 Ethernet Level (PCP)	54
24.4 Putting things together	55
24.4.1 Full example of QoS for osmo-bts uplink QoS	56
<b>25 VTY Process and Thread management</b>	<b>56</b>
25.1 Scheduling Policy	57
25.2 CPU-Affinity Mask	57
<b>26 TRX Manager UDP socket interface</b>	<b>58</b>
26.1 Indications on the Master Clock Interface	59
26.2 TRXC protocol	59
26.2.1 Power Control	59
26.2.2 Tuning Control	60
26.2.3 Training Sequence configuration	60

26.2.4	Timeslot Control . . . . .	60
26.2.4.1	Multiple Training Sequences (optional) . . . . .	61
26.2.4.2	VAMOS enabled channel combinations (optional) . . . . .	61
26.2.5	TRXD header version negotiation . . . . .	64
26.3	TRXD protocol . . . . .	64
26.3.1	PDU versioning . . . . .	64
26.3.2	Uplink PDU format . . . . .	65
26.3.2.1	Coding of MTS: Modulation and Training Sequence info . . . . .	67
26.3.3	Downlink Data Burst . . . . .	68
26.3.4	PDU batching . . . . .	70
26.3.5	Coding of VAMOS PDUs . . . . .	71
<b>27</b>	<b>Osmocom Control Interface</b>	<b>72</b>
27.1	Control Interface Protocol . . . . .	72
27.1.1	GET operation . . . . .	73
27.1.2	SET operation . . . . .	73
27.1.3	TRAP operation . . . . .	74
27.2	Common variables . . . . .	74
27.3	Control Interface python examples . . . . .	75
27.3.1	Getting rate counters . . . . .	75
27.3.2	Setting a value . . . . .	75
27.3.3	Getting a value . . . . .	75
27.3.4	Listening for traps . . . . .	75
<b>28</b>	<b>Glossary</b>	<b>76</b>
<b>A</b>	<b>Osmocom TCP/UDP Port Numbers</b>	<b>84</b>
<b>B</b>	<b>Bibliography / References</b>	<b>85</b>
B.0.0.0.1	References . . . . .	85
<b>C</b>	<b>GNU Free Documentation License</b>	<b>90</b>
C.1	PREAMBLE . . . . .	90
C.2	APPLICABILITY AND DEFINITIONS . . . . .	90
C.3	VERBATIM COPYING . . . . .	91
C.4	COPYING IN QUANTITY . . . . .	91
C.5	MODIFICATIONS . . . . .	91
C.6	COMBINING DOCUMENTS . . . . .	93
C.7	COLLECTIONS OF DOCUMENTS . . . . .	93
C.8	AGGREGATION WITH INDEPENDENT WORKS . . . . .	93
C.9	TRANSLATION . . . . .	93



---

C.10 TERMINATION . . . . .	93
C.11 FUTURE REVISIONS OF THIS LICENSE . . . . .	94
C.12 RELICENSING . . . . .	94
C.13 ADDENDUM: How to use this License for your documents . . . . .	94

# 1 Foreword

Digital cellular networks based on the GSM specification were designed in the late 1980s and first deployed in the early 1990s in Europe. Over the last 25 years, hundreds of networks were established globally and billions of subscribers have joined the associated networks.

The technological foundation of GSM was based on multi-vendor interoperable standards, first created by government bodies within CEPT, then handed over to ETSI, and now in the hands of 3GPP. Nevertheless, for the first 17 years of GSM technology, the associated protocol stacks and network elements have only existed in proprietary *black-box* implementations and not as Free Software.

In 2008 Dieter Spaar and I started to experiment with inexpensive end-of-life surplus Siemens GSM BTSs. We learned about the A-bis protocol specifications, reviewed protocol traces and started to implement the BSC-side of the A-bis protocol as something originally called `bs11-abis`. All of this was *just for fun*, in order to learn more and to boldly go where no Free Software developer has gone before. The goal was to learn and to bring Free Software into a domain that despite its ubiquity, had not yet seen any Free / Open Source software implementations.

`bs11-abis` quickly turned into `bsc-hack`, then *OpenBSC* and its *OsmoNITB* variant: A minimal implementation of all the required functionality of an entire GSM network, exposing A-bis towards the BTS. The project attracted more interested developers, and surprisingly quickly also commercial interest, contribution and adoption. This allowed adding support for more BTS models.

After having implemented the network-side GSM protocol stack in 2008 and 2009, in 2010 the same group of people set out to create a telephone-side implementation of the GSM protocol stack. This established the creation of the Osmocom umbrella project, under which OpenBSC and the OsmocomBB projects were hosted.

Meanwhile, more interesting telecom standards were discovered and implemented, including TETRA professional mobile radio, DECT cordless telephony, GMR satellite telephony, some SDR hardware, a SIM card protocol tracer and many others.

Increasing commercial interest particularly in the BSS and core network components has lead the way to 3G support in Osmocom, as well as the split of the minimal *OsmoNITB* implementation into separate and fully featured network components: OsmoBSC, OsmoMSC, OsmoHLR, OsmoMGW and OsmoSTP (among others), which allow seamless scaling from a simple "Network In The Box" to a distributed installation for serious load.

It has been a most exciting ride during the last eight-odd years. I would not have wanted to miss it under any circumstances.

—Harald Welte, Osmocom.org and OpenBSC founder, December 2017.

## 1.1 Acknowledgements

My deep thanks to everyone who has contributed to Osmocom. The list of contributors is too long to mention here, but I'd like to call out the following key individuals and organizations, in no particular order:

- Dieter Spaar for being the most amazing reverse engineer I've met in my career
- Holger Freyther for his many code contributions and for shouldering a lot of the maintenance work, setting up Jenkins - and being crazy enough to co-start sysmocom as a company with me ;)
- Andreas Eversberg for taking care of Layer2 and Layer3 of OsmocomBB, and for his work on OsmoBTS and OsmoPCU
- Sylvain Munaut for always tackling the hardest problems, particularly when it comes closer to the physical layer
- Chaos Computer Club for providing us a chance to run real-world deployments with tens of thousands of subscribers every year
- Bernd Schneider of Netzing AG for funding early ip.access nanoBTS support
- On-Waves ehf for being one of the early adopters of OpenBSC and funding a never ending list of features, fixes and general improvement of pretty much all of our GSM network element implementations
- sysmocom, for hosting and funding a lot of Osmocom development, the annual Osmocom Developer Conference and releasing this manual.

- Jan Luebbe, Stefan Schmidt, Daniel Willmann, Pablo Neira, Nico Golde, Kevin Redon, Ingo Albrecht, Alexander Huemer, Alexander Chemeris, Max Suraev, Tobias Engel, Jacob Erlbeck, Ivan Kluchnikov
- NLnet Foundation, for providing funding for a number of individual work items within the Osmocom universe, such as LTE support in OsmoCBC or GPRS/EGPRS support for Ericsson RBS6000.
- WaveMobile Ltd, for many years of sponsoring.

May the source be with you!

—Harald Welte, Osmocom.org and OpenBSC founder, January 2016.

## 1.2 Endorsements

This version of the manual is endorsed by Harald Welte as the official version of the manual.

While the GFDL license (see Appendix C) permits anyone to create and distribute modified versions of this manual, such modified versions must remove the above endorsement.

## 2 Preface

First of all, we appreciate your interest in Osmocom software.

Osmocom is a Free and Open Source Software (FOSS) community that develops and maintains a variety of software (and partially also hardware) projects related to mobile communications.

Founded by people with decades of experience in community-driven FOSS projects like the Linux kernel, this community is built on a strong belief in FOSS methodology, open standards and vendor neutrality.

### 2.1 FOSS lives by contribution!

If you are new to FOSS, please try to understand that this development model is not primarily about “free of cost to the GSM network operator”, but it is about a collaborative, open development model. It is about sharing ideas and code, but also about sharing the effort of software development and maintenance.

If your organization is benefiting from using Osmocom software, please consider ways how you can contribute back to that community. Such contributions can be many-fold, for example

- sharing your experience about using the software on the public mailing lists, helping to establish best practises in using/operating it,
- providing qualified bug reports, workarounds
- sharing any modifications to the software you may have made, whether bug fixes or new features, even experimental ones
- providing review of patches
- testing new versions of the related software, either in its current “master” branch or even more experimental feature branches
- sharing your part of the maintenance and/or development work, either by donating developer resources or by (partially) funding those people in the community who do.

We're looking forward to receiving your contributions.

## 2.2 Osmocom and sysmocom

Some of the founders of the Osmocom project have established *sysmocom - systems for mobile communications GmbH* as a company to provide products and services related to Osmocom.

sysmocom and its staff have contributed by far the largest part of development and maintenance to the Osmocom mobile network infrastructure projects.

As part of this work, sysmocom has also created the manual you are reading.

At sysmocom, we draw a clear line between what is the Osmocom FOSS project, and what is sysmocom as a commercial entity. Under no circumstances does participation in the FOSS projects require any commercial relationship with sysmocom as a company.

## 2.3 Corrections

We have prepared this manual in the hope that it will guide you through the process of installing, configuring and debugging your deployment of cellular network infrastructure elements using Osmocom software. If you do find errors, typos and/or omissions, or have any suggestions on missing topics, please do take the extra time and let us know.

## 2.4 Legal disclaimers

### 2.4.1 Spectrum License

As GSM and UMTS operate in licensed spectrum, please always double-check that you have all required licenses and that you do not transmit on any ARFCN or UARFCN that is not explicitly allocated to you by the applicable regulatory authority in your country.



#### Warning

Depending on your jurisdiction, operating a radio transmitter without a proper license may be considered a felony under criminal law!

---

### 2.4.2 Software License

The software developed by the Osmocom project and described in this manual is Free / Open Source Software (FOSS) and subject to so-called *copyleft* licensing.

Copyleft licensing is a legal instrument to ensure that this software and any modifications, extensions or derivative versions will always be publicly available to anyone, for any purpose, under the same terms as the original program as developed by Osmocom.

This means that you are free to use the software for whatever purpose, make copies and distribute them - just as long as you ensure to always provide/release the *complete and corresponding* source code.

Every Osmocom software includes a file called `COPYING` in its source code repository which explains the details of the license. The majority of programs is released under GNU Affero General Public License, Version 3 (AGPLv3).

If you have any questions about licensing, don't hesitate to contact the Osmocom community. We're more than happy to clarify if your intended use case is compliant with the software licenses.

### 2.4.3 Trademarks

All trademarks, service marks, trade names, trade dress, product names and logos appearing in this manual are the property of their respective owners. All rights not expressly granted herein are reserved.

For your convenience we have listed below some of the registered trademarks referenced herein. This is not a definitive or complete list of the trademarks used.

*Osmocom*® and *OpenBSC*® are registered trademarks of Holger Freyther and Harald Welte.

*sysmocom*® and *sysmoBTS*® are registered trademarks of *sysmocom - systems for mobile communications GmbH*.

*ip.access*® and *nanoBTS*® are registered trademarks of *ip.access Ltd*.

#### 2.4.4 Liability

The software is distributed in the hope that it will be useful, but WITHOUT ANY WARRANTY; without even the implied warranty of MERCHANTABILITY or FITNESS FOR A PARTICULAR PURPOSE. See the License text included with the software for more details.

#### 2.4.5 Documentation License

Please see Appendix C for further information.

## 3 Introduction

### 3.1 Required Skills

Please note that even while the capital expenses of running mobile networks has decreased significantly due to Osmocom software and associated hardware like sysmoBTS, GSM networks are still primarily operated by large GSM operators.

Neither the GSM specification nor the GSM equipment was ever designed for networks to be installed and configured by anyone but professional GSM engineers, specialized in their respective area like radio planning, radio access network, back-haul or core network.

If you do not share an existing background in GSM network architecture and GSM protocols, correctly installing, configuring and optimizing your GSM network will be tough, irrespective whether you use products with Osmocom software or those of traditional telecom suppliers.

GSM knowledge has many different fields, from radio planning through site installation to core network configuration/administration.

The detailed skills required will depend on the type of installation and/or deployment that you are planning, as well as its associated network architecture. A small laboratory deployment for research at a university is something else than a rural network for a given village with a handful of cells, which is again entirely different from an urban network in a dense city.

Some of the useful skills we recommend are:

- general understanding about RF propagation and path loss in order to estimate coverage of your cells and do RF network planning.
- general understanding about GSM network architecture, its network elements and key transactions on the Layer 3 protocol
- general understanding about voice telephony, particularly those of ISDN heritage (Q.931 call control)
- understanding of GNU/Linux system administration and working on the shell
- understanding of TCP/IP networks and network administration, including tcpdump, tshark, wireshark protocol analyzers.
- ability to work with text based configuration files and command-line based interfaces such as the VTY of the Osmocom network elements

## 3.2 Getting assistance

If you do have a support package / contract with sysmocom (or want to get one), please contact [support@sysmocom.de](mailto:support@sysmocom.de) with any issues you may have.

If you don't have a support package / contract, you have the option of using the resources put together by the Osmocom community at <https://projects.osmocom.org/>, checking out the wiki and the mailing-list for community-based assistance. Please always remember, though: The community has no obligation to help you, and you should address your requests politely to them. The information (and software) provided at osmocom.org is put together by volunteers for free. Treat them like a friend whom you're asking for help, not like a supplier from whom you have bought a service.

If you would like to obtain professional/commercial support on Osmocom CNI, you can always reach out to [sales@sysmocom.de](mailto:sales@sysmocom.de) to discuss your support needs. Purchasing support from sysmocom helps to cover the ongoing maintenance of the Osmocom CNI software stack.

## 4 Overview

### 4.1 About this manual

This manual should help you getting started with the OsmoBTS software. It will cover aspects of configuring and running OsmoBTS as well as some introduction about its internal architecture and external interfaces.

### 4.2 About OsmoBTS

OsmoBTS is an implementation of a GSM BTS (Base Transceiver Station). A BTS serves as the interface between the Um radio interface towards phones and the wired Abis interface towards the BSC (Base Station Controller). It also implements the network side of the Layer 2 of the Um radio interface: The LAPDm protocol.

OsmoBTS is licensed as Free and Open Source Software (FOSS) under *GNU AGPLv3* [[gnu-agplv3](#)]. It is developed as one GSM network infrastructure component part of the overall Osmocom project.

As perhaps the first implementation of a GSM BTS ever in the industry, OsmoBTS is implemented in a vendor-independent way and supports a large variety of transceiver hardware and physical layer implementations from many vendors.

### 4.3 Credits

OsmoBTS was originally developed in 2011 by Andreas Eversberg and Harald Welte. It has since been maintained by Harald Welte and Holger Freyther at sysmocom.

### 4.4 OsmoBTS in the Osmocom GSM network architecture

OsmoBTS can be used in combination with the various other GSM network elements developed under the umbrella of the Osmocom project.

Typical configurations either use OsmoBTS with OsmoBSC, or with OsmoNITB, as can be seen in the following figures.

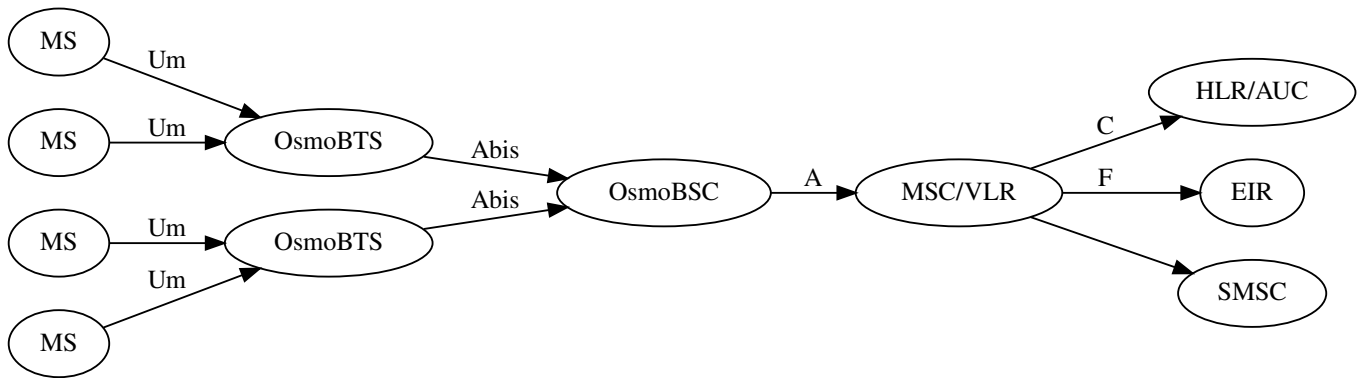

Figure 1: Classic GSM architecture using OsmoBTS with OsmoBTS components

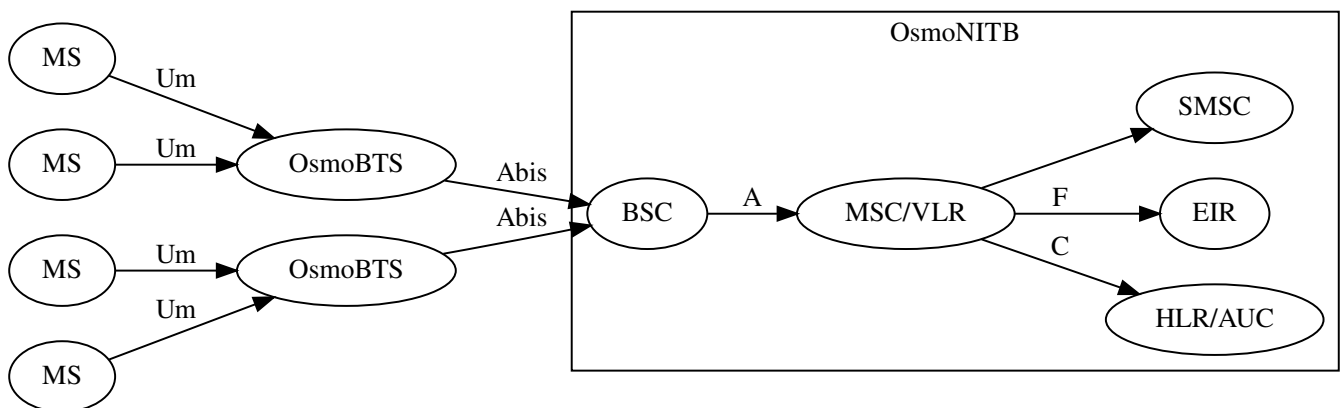

Figure 2: GSM architecture using OsmoBTS + OsmoNITB

If intended by the user, it is of course also possible to implement an OsmoBTS-compatible Abis-over-IP interface in any third party BSC. The Abis/IP interface and its protocol are documented in the *OsmoBTS Abis Protocol Specification* [[osmobts-abis-spec](#)]. However, be advised that such a configuration is currently not officially supported by Osmocom.

## 5 Abis/IP Interface

### 5.1 A-bis Operation & Maintenance Link

The GSM Operation & Maintenance Link (OML) is specified in 3GPP TS 12.21 and is used between a GSM Base-Transceiver-Station (BTS) and a GSM Base-Station-Controller (BSC). The default TCP port for OML is *3002*. The connection will be opened from the BTS to the BSC.

Abis OML is only specified over E1 interfaces. The Abis/IP implementation of OsmoBTS and OsmoBSC extend and/or deviate from the TS 12.21 specification in several ways. Please see the *OsmoBTS Abis Protocol Specification* [[osmobts-abis-spec](#)] for more information.

### 5.2 A-bis Radio Signalling Link

The GSM Radio Signalling Link (RSL) is specified in 3GPP TS 08.58 and is used between a GSM Base-Transceiver-Station and a GSM Base-Station-Controller (BSC). The default TCP port for RSL is *3003*. The connection will be opened from the BTS to BSC after it has been instructed by the BSC.

Abis RSL is only specified over E1 interfaces. The Abis/IP implementation of OsmoBTS and OsmoBSC extend and/or deviate from the TS 08.58 specification in several ways. Please see the *OsmoBTS Abis Protocol Specification* [[osmobts-abis-spec](#)] for more information.

## 5.3 Locate Abis/IP based BTS

We can use a tool called `abisip-find` to be able to find BTS which is connected in the network. This tool is located in the OsmoBSC project repository under: `./src/ipaccess`

### 5.3.1 abisip-find

`abisip-find` is a small command line tool which is used to search and find BTS devices in your network (e.g. `sysmoBTS`, `nanoBTS`).

It uses broadcast packets of the UDP variant of the Abis-IP protocol on port 3006, and thus will find any BTS that can be reached by the all-network broadcast address 255.255.255.255

When program is started it will print one line for each BTS it can find.

#### Example: using `abisip-find` to find BTS in your network

```
$ ./abisip-find
abisip-find (C) 2009 by Harald Welte
This is FREE SOFTWARE with ABSOLUTELY NO WARRANTY

you might need to specify the outgoing
network interface, e.g. ``abisip-find eth0``
Trying to find ip.access BTS by broadcast UDP...

MAC_Address='24:62:78:01:02:03' IP_Address='192.168.0.171' Serial_Number='123'
Unit_ID='sysmoBTS 1002'

MAC_Address='24:62:78:04:05:06' IP_Address='192.168.0.182' Serial_Number='456'
Unit_ID='sysmoBTS 1002'

MAC Address='00:01:02:03:04:05' IP Address='192.168.100.123' Unit ID='65535/0/0'
Location_1='' Location 2='BTS_NBT131G' Equipment Version='165a029_55'
Software Version='168a302_v142b13d0' Unit Name='nbts-00-02-95-00-4E-B3'
Serial Number='00123456'

^C
```

You may have to start the program as a root:

```
$ sudo ./abisip-find eth0
```

## 5.4 Deploying a new nanoBTS

A tool called `ipaccess-config` can be used to configure a new `ip.access nanoBTS`.

### 5.4.1 ipaccess-config

This program is very helpful tool which is used to configure Unit ID and Primary OML IP. You can find this tool in the OsmoBSC repository under: `./src/ipaccess`

#### Example: using `ipaccess-config` to configure Unit ID and Primary OML IP of nanoBTS



```
$ ./ipaccess-config -u 1801/0/01 10.9.1.1952 -o 10.9.1.1543

ipaccess-config (C) 2009-2010 by Harald Welte and others
This is FREE SOFTWARE with ABSOLUTELY NO WARRANTY

Trying to connect to ip.access BTS ...
abis_nm.c:316 OC=SITE-MANAGER(00) INST=(ff,ff,ff) STATE CHG:
OP_STATE=Disabled AVAIL=Not installed(07)
abis_nm.c:316 OC=BTS(01) INST=(00,ff,ff) STATE CHG:
OP_STATE=Disabled AVAIL=Not installed(07) ADM=Locked
abis_nm.c:316 OC=BASEBAND-TRANSCEIVER(04) INST=(00,00,ff) STATE CHG:
OP_STATE=Disabled AVAIL=Not installed(07) ADM=Locked
OML link established using TRX 0
setting Unit ID to '1801/0/0'
setting primary OML link IP to '10.9.1.154'
abis_nm.c:316 OC=CHANNEL(03) INST=(00,00,00) STATE CHG:
OP_STATE=Disabled AVAIL=Not installed(07) ADM=Locked
...
abis_nm.c:2433 OC=BASEBAND-TRANSCEIVER(04) INST=(00,00,ff) IPACCESS(0xf0):
SET NVATTR ACK
Set the NV Attributes.
```

- <sup>1</sup> Unit ID
- <sup>2</sup> IP address of the NITB
- <sup>3</sup> IP address of the nanoBTS

## 6 OsmoBTS Interfaces

OsmoBTS offers a set of interfaces to interact with external entities:

- A-bis/IP interface to talk to the BSC
- bts\_model specific PHY interface
- VTY interface
- Osmocom control interface
- GSMTAP interface
- PCU interface

### 6.1 OsmoBTS Abis/IP Interface

OsmoBTS implements the GSM A-bis interface as described in the relevant 3GPP specifications:

- A-bis RSL according to 3GPP TS 08.58
- A-bis OML according to 3GPP TS 12.21

As the 3GPP specifies A-bis only over E1 interfaces and not over IP, significant enhancements and modifications to the 3GPP specifications are employed. Nevertheless, the implementation tries to stay as close as possible to the 3GPP specifications.

Please see the *OsmoBTS Abis Protocol Specification* [[osmobts-abis-spec](#)] for more information on this subject.

## 6.2 bts\_model specific PHY interface

This interface is specific to the bts\_model that OsmoBTS was compiled for. It can take any form as required by the respective hardware.

Please see the PHY documentation of your respective BTS hardware for more details.

## 6.3 OsmoBTS VTY Interface

See Section 12 for further information.

## 6.4 OsmoBTS Control Interface

The general structure of the Osmocom control interface is described in Section 27.

The number of control interface commands/attributes is currently quite limited and largely depends on the bts\_model used.

### 6.4.1 trx.N.thermal-attenuation

The idea of this parameter is to attenuate the system output power as part of thermal management. In some cases the PA might be passing a critical level, so an external control process can use this attribute to reduce the system output power.

Please note that all values in the context of transmit power calculation are integers in milli-dB (1/10000 bel), so the below example is setting the attenuation at 3 dB:

```
bsc_control.py -d localhost -p 4238 -s trx.0.thermal-attenuation 3000
Got message: SET_REPLY 1 trx.0.thermal-attenuation 3000
```

```
bsc_control.py -d localhost -p 4238 -g trx.0.thermal-attenuation
Got message: GET_REPLY 1 trx.0.thermal-attenuation 3000
```

## 6.5 OsmoBTS GSMTAP Interface

GSMTAP is a standard created by Osmocom to UDP-encapsulate GSM protocol messages normally communicated over non-IP interfaces for the primary purpose of protocol analysis in the wireshark dissector.

The initial purpose was to encapsulate GSM Um frames including some meta-data like ARFCN and GSM frame number into something that can be parsed and dispatched within the wireshark dissector.

This interface has since been extended to many other GSM/GPRS/UMTS interfaces and protocols, and even to TETRA and GMR.

In OsmoBTS, it is possible to export both uplink and downlink Um messages via GSMTAP. There is a set of VTY configuration options to specify for which logical channels of the Um interface GSMTAP messages shall be emitted, and to which destination IP address they shall be sent.

Using GSMTAP it is possible to place a virtual tap at the air interface between BTS and MS, without going through the trouble of setting up an actual radio receiver at the same frequencies. Also, GSMTAP export is performed before the Um air-interface encryption (A5) is performed, so all frames are always in plain text.

Please refer to Section 14.2.2 for more information on how to configure and use this interface.

## 6.6 OsmoBTS PCU Socket Interface

In order to assist the provisioning of GPRS services over the same radio interface as circuit-switched GSM, OsmoBTS exposes a Unix domain socket based interface towards OsmoPCU.

OsmoPCU is the Osmocom implementation of the GPRS Packet Control Unit (PCU), which is co-located with the BTS in the Osmocom implementation. Contrary to that, many classic E1-based implementations of the GSM RAN co-locate the PCU with the BSC. However, the GSM specifications keep the location up to the implementor.

The GPRS network architecture is shown in Figure 3.

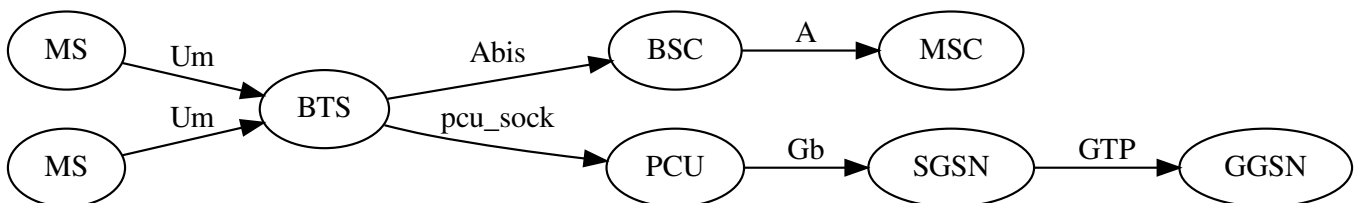

Figure 3: GPRS network architecture

The PCU socket interface serves the following purposes:

- to pass PCU relevant configuration from BTS to PCU
- to forward paging requests from BTS to PCU
- to forward RACH Requests from BTS to PCU

Depending on your `bts_model`, the PCU may also be passing actual PH-DATA.request / PH-DATA.indication / PH-RTS.indication primitives for the PDCH. This is considered sub-optimal, and some BTS models offer a direct interface by which the PCU can exchange those primitives directly with the PHY.

The default PCU socket interface name is `/tmp/pcu_socket`, but this can be overridden by the `pcu-socket` VTY command in the BTS configuration VTY node.

## 7 Control interface

The actual protocol is described in Section 27, the variables common to all programs using it are described in Section 27.2. Here we describe variables specific to OsmoBTS. The commands starting with prefix "net.btsN." are specific to a certain BTS so N have to be replaced with BTS number when issuing command. Similarly the TRX-specific commands are additionally prefixed with TRX number e. g. "net.bts1.trx2.thermal-attenuation".

Table 1: Variables available over control interface

Name	Access	Trap	Value	Comment
net.btsN.trxM.thermal-attenuation	RW	No	integer	See Section 7.1 for details.

### 7.1 thermal-attenuation

Allowed SET value for thermal attenuation is between 0 to 40 dB. Note: the value is SET in dB units but GET will return value in mdB units used internally.

## 8 Osmocom Counters

The following gives an overview of all the types of counters available:

### 8.1 Osmo Counters (deprecated)

Osmo counters are the oldest type of counters added to Osmocom projects. They are not grouped.

- Printed as part of VTY show stats
- Increment, Decrement
- Accessible through the control interface: counter.<counter\_name>

### 8.2 Rate Counters

Rate counters count rates of events.

- Printed as part of VTY show stats
- Intervals: per second, minute, hour, day or absolute value
- Increment only
- Accessible through the control interface
- Rate counters are grouped and different instances per group can exist

The control interface command to get a counter (group) is:

```
rate_ctr.per_{sec,min,hour,day,abs}.<group_name>.<idx>.[counter_name]
```

It is possible to get all counters in a group by omitting the counter name

### 8.3 Stat Item

Stat items are a grouped replacement for osmo counters.

- Printed as part of VTY show stats
- Replacement for osmo counters
- Not yet available through the control interface
- Grouped and indexed like rate counters
- Items have a unit
- Keeps a list of the last values measured, so could return an average, min, max, std. deviation. So far this is not implemented in any of the reporting options.

### 8.4 Statistic Levels

There are three levels on which a statistic can be aggregated in Osmocom projects: globally, per-peer and per-subscriber.

#### 8.4.1 Global

These are global statistics.

### 8.4.2 Peer

These statistics relate to a peer the program connects to such as the NSVC in an SGSN.

This level also includes reporting global statistics.

### 8.4.3 Subscriber

These statistics are related to an individual mobile subscriber. An example would be bytes transferred in an SGSN PDP context.

This level also includes global and peer-based statistics.

## 8.5 Stats Reporter

The stats reporter periodically collects osmo counter, rate counter and stat item values and sends them to a backend. Currently implemented are outputting to the configured log targets and a statsd connector.

### 8.5.1 Configuring a stats reporter

Periodically printing the statistics to the log can be done in the following way:

---

#### Example 8.1 Log statistics

---

```
OsmoBSC> enable
OsmoBSC# configure terminal
OsmoBSC(config)# stats interval 60 ❶
OsmoBSC(config)# stats reporter log ❷
OsmoBSC(config-stats)# level global ❸
OsmoBSC(config-stats)# enable ❹
```

- ❶ The interval determines how often the statistics are reported.
- ❷ Write the statistic information to any configured log target.
- ❸ Report only global statistics (can be global, peer, or subscriber).
- ❹ Enable the reporter, disable will disable it again.

The counter values can also be sent to any aggregation/visualization tool that understands the statsd format, for example a statsd server with graphite or prometheus using the statsd\_exporter together with grafana.

The statsd format is specified in [https://github.com/b/statsd\\_spec](https://github.com/b/statsd_spec)

---

#### Example 8.2 Report statistics to statsd

---

```
OsmoBSC> enable
OsmoBSC# configure terminal
OsmoBSC(config)# stats interval 10
OsmoBSC(config)# stats reporter statsd ❶
OsmoBSC(config-stats)# prefix BSC1 ❷
OsmoBSC(config-stats)# level subscriber ❸
OsmoBSC(config-stats)# remote-ip 1.2.3.4 ❹
OsmoBSC(config-stats)# remote-port 8125 ❺
OsmoBSC(config-stats)# enable
```

- ❶ Configure the statsd reporter.

- 2 Prefix the reported statistics. This is useful to distinguish statistics from multiple instances of the same service.
- 3 Report only `global` statistics or include `peer` or `subscriber` statistics as well.
- 4 IP address of the statsd server.
- 5 UDP port of the statsd server. Statsd by default listens to port 8125.

You can use Netdata (<https://learn.netdata.cloud/>) as a statsd server which does not require special configuration to show rate counters. By default all the rate counters will be exposed to the StatsD plugin (listening on 127.0.0.1:8125) and displayed on the Netdata dashboard available via: <http://localhost:19999> The list of available charts which includes all the rate counters reported via statsD is available through: <http://localhost:19999/api/v1/charts>

## 8.6 Socket stats

libsmocore provides features to monitor the status of TCP connections. This can be a helpful source of information when the links between network components are unreliable (e.g. satellite link between BTS and BSC).

---

### Note

This feature is only available for certain types of TCP connections. At the moment only RSL/OML connections between OsmoBSC and the connected BTSs can be monitored.

---

### 8.6.1 Configuration

The gathering of the TCP connection statistics is done via syscalls. This has to be taken into account for the configuration. Since syscalls are rather expensive and time consuming the overall performance of the application may suffer when many TCP connections are present. This may be the case for BSCs with a large number of BTSs connected to it.

The statistics are gathered in batches per interval. A batch size of 5 would mean that only 5 TCP connections per interval are evaluated and the next 5 connections in the next interval and so on.

It is recommended to choose a large reporting interval and a reasonable small batch size to distribute the syscall load as even as possible.

---

#### Example 8.3 Report statistics to statsd

```
OsmoBSC> enable
OsmoBSC# configure terminal
stats-tcp interval 10 ❶
stats-tcp batch-size 5 ❷
```

---

- ❶ Set the gathering interval (sec.)
- ❷ Set how many TCP sockets statistics to gather per interval.

### 8.6.2 Generated stats items

Name	Description
tcp:unacked	unacknowledged packets.
tcp:lost	unacknowledged packets.
tcp:retrans	lost packets.
tcp:rtt	retransmitted packets.
tcp:rcv_rtt	roundtrip-time (receive).
tcp:notsent_bytes	bytes not yet sent.

Name	Description
tcp:rwnd_limited	time (usec) limited by receive window.
tcp:sndbuf_limited	Time (usec) limited by send buffer.
tcp:reord_seen	reordering events seen.

The item group index is the file descriptor number. The item group name consists of a static prefix (e.g. "ipa-rsl"), followed by the IP addresses and ports of both peers.

#### Example 8.4 VTY output of a stats item group of a TCP connection

```
stats tcp (15) ('ipa-rsl,r=10.9.1.143:38455<->l=10.9.1.162:3003') :
unacknowledged packets:      0
lost packets:                0
retransmitted packets:      0
roundtrip-time:              583
roundtrip-time (receive):    0
bytes not yet sent:          0
time (usec) limited by receive window:      0
Time (usec) limited by send buffer:         0
reordering events seen:      0
```

## 9 Counters

These counters and their description based on OsmoBTS 0.8.1.346-33ed (OsmoBTS).

### 9.1 Rate Counters

Table 2: e1inp - E1 Input subsystem

Name	Reference	Description
hdlc:abort	[?]	HDLC abort
hdlc:bad_fcs	[?]	HLDC Bad FCS
hdlc:overrun	[?]	HDLC Overrun
alarm	[?]	Alarm
removed	[?]	Line removed

Table 3: cbch - cell broadcast channel

Name	Reference	Description
cbch:rcvd_queued	[?]	Received + queued CBCH messages (Abis)
cbch:rcvd_dropped	[?]	Received + dropped CBCH messages (Abis)
cbch:sent_single	[?]	Sent single CBCH messages (Um)
cbch:sent_default	[?]	Sent default CBCH messages (Um)
cbch:sent_null	[?]	Sent NULL CBCH messages (Um)

Table 4: cbch - cell broadcast channel

Name	Reference	Description
cbch:rcvd_queued	[?]	Received + queued CBCH messages (Abis)
cbch:rcvd_dropped	[?]	Received + dropped CBCH messages (Abis)
cbch:sent_single	[?]	Sent single CBCH messages (Um)
cbch:sent_default	[?]	Sent default CBCH messages (Um)
cbch:sent_null	[?]	Sent NULL CBCH messages (Um)

Table 5: bts - base transceiver station

Name	Reference	Description
paging:rcvd	[?]	Received paging requests (Abis)
paging:drop	[?]	Dropped paging requests (Abis)
paging:sent	[?]	Sent paging requests (Um)
rach:rcvd	[?]	Received RACH requests (Um)
rach:drop	[?]	Dropped RACH requests (Um)
rach:handover	[?]	Received RACH requests (Handover)
rach:cs	[?]	Received RACH requests (CS/Abis)
rach:ps	[?]	Received RACH requests (PS/PCU)
agch:rcvd	[?]	Received AGCH requests (Abis)
agch:sent	[?]	Sent AGCH requests (Abis)
agch:delete	[?]	Sent AGCH DELETE IND (Abis)

## 10 Osmo Stat Items

## 11 Osmo Counters

## 12 The Osmocom VTY Interface

All human interaction with Osmocom software is typically performed via an interactive command-line interface called the *VTY*.

---

### Note

Integration of your programs and scripts should **not** be done via the telnet VTY interface, which is intended for human interaction only: the VTY responses may arbitrarily change in ways obvious to humans, while your scripts' parsing will likely break often. For external software to interact with Osmocom programs (besides using the dedicated protocols), it is strongly recommended to use the Control interface instead of the VTY, and to actively request / implement the Control interface commands as required for your use case.

---

The interactive telnet VTY is used to

- explore the current status of the system, including its configuration parameters, but also to view run-time state and statistics,
- review the currently active (running) configuration,
- perform interactive changes to the configuration (for those items that do not require a program restart),



- store the current running configuration to the config file,
- enable or disable logging; to the VTY itself or to other targets.

The Virtual Tele Type (VTY) has the concept of *nodes* and *commands*. Each command has a name and arguments. The name may contain a space to group several similar commands into a specific group. The arguments can be a single word, a string, numbers, ranges or a list of options. The available commands depend on the current node. there are various keyboard shortcuts to ease finding commands and the possible argument values.

Configuration file parsing during program start is actually performed the VTY's CONFIG node, which is also available in the telnet VTY. Apart from that, the telnet VTY features various interactive commands to query and instruct a running Osmocom program. A main difference is that during config file parsing, consistent indenting of parent vs. child nodes is required, while the interactive VTY ignores indenting and relies on the *exit* command to return to a parent node.

---

#### Note

In the *CONFIG* node, it is not well documented which commands take immediate effect without requiring a program restart. To save your current config with changes you may have made, you may use the `write file` command to **overwrite** your config file with the current configuration, after which you should be able to restart the program with all changes taking effect.

---

This chapter explains most of the common nodes and commands. A more detailed list is available in various programs' VTY reference manuals, e.g. see [\[vty-ref-osmomsc\]](#).

There are common patterns for the parameters, these include IPv4 addresses, number ranges, a word, a line of text and choice. The following will explain the commonly used syntactical patterns:

Table 6: VTY Parameter Patterns

Pattern	Example	Explanation
A.B.C.D	127.0.0.1	An IPv4 address
A.B.C.D/M	192.168.1.0/24	An IPv4 address and mask
X:X::X:X	::1	An IPv6 address
X:X::X:X/M	::1/128	An IPv6 address and mask
TEXT	example01	A single string without any spaces, tabs
.TEXT	Some information	A line of text
(OptionA OptionB OptionC)	OptionA	A choice between a list of available options
<0-10>	5	A number from a range

## 12.1 Accessing the telnet VTY

The VTY of a given Osmocom program is implemented as a telnet server, listening to a specific TCP port.

Please see Appendix A to check for the default TCP port number of the VTY interface of the specific Osmocom software you would like to connect to.

As telnet is insecure and offers neither strong authentication nor encryption, the VTY by default only binds to localhost (127.0.0.1) and will thus not be reachable by other hosts on the network.



#### Warning

By default, any user with access to the machine running the Osmocom software will be able to connect to the VTY. We assume that such systems are single-user systems, and anyone with local access to the system also is authorized to access the VTY. If you require stronger security, you may consider using the packet filter of your operating system to restrict access to the Osmocom VTY ports further.

---

## 12.2 VTY Nodes

The VTY by default has the following minimal nodes:

### VIEW

When connecting to a telnet VTY, you will be on the *VIEW* node. As its name implies, it can only be used to view the system status, but it does not provide commands to alter the system state or configuration. As long as you are in the non-privileged *VIEW* node, your prompt will end in a > character.

### ENABLE

The *ENABLE* node is entered by the `enable` command, from the *VIEW* node. Changing into the *ENABLE* node will unlock all kinds of commands that allow you to alter the system state or perform any other change to it. The *ENABLE* node and its children are signified by a # character at the end of your prompt.

You can change back from the *ENABLE* node to the *VIEW* node by using the `disable` command.

### CONFIG

The *CONFIG* node is entered by the `configure terminal` command from the *ENABLE* node. The config node is used to change the run-time configuration parameters of the system. The prompt will indicate that you are in the config node by a (config) # prompt suffix.

You can always leave the *CONFIG* node or any of its children by using the `end` command.

This node is also automatically entered at the time the configuration file is read. All configuration file lines are processed as if they were entered from the VTY *CONFIG* node at start-up.

### Other

Depending on the specific Osmocom program you are running, there will be few or more other nodes, typically below the *CONFIG* node. For example, the OsmoBSC has nodes for each BTS, and within the BTS node one for each TRX, and within the TRX node one for each Timeslot.

## 12.3 Interactive help

The VTY features an interactive help system, designed to help you to efficiently navigate is commands.

---

### Note

The VTY is present on most Osmocom GSM/UMTS/GPRS software, thus this chapter is present in all the relevant manuals. The detailed examples below assume you are executing them on the OsmoMSC VTY. They will work in similar fashion on the other VTY interfaces, while the node structure will differ in each program.

---

### 12.3.1 The question-mark (?) command

If you type a single ? at the prompt, the VTY will display possible completions at the exact location of your currently entered command.

If you type ? at an otherwise empty command (without having entered even only a partial command), you will get a list of the first word of all possible commands available at this node:

#### Example: Typing ? at start of OsmoMSC prompt

```
OsmoMSC> ⓘ
  show      Show running system information
  list      Print command list
  exit      Exit current mode and down to previous mode
  help      Description of the interactive help system
  enable    Turn on privileged mode command
  terminal   Set terminal line parameters
  who       Display who is on vty
  logging   Configure logging
  no        Negate a command or set its defaults
  sms       SMS related commands
  subscriber Operations on a Subscriber
```

- ① Type `?` here at the prompt, the `?` itself will not be printed.

If you have already entered a partial command, `?` will help you to review possible options of how to continue the command. Let's say you remember that `show` is used to investigate the system status, but you don't remember the exact name of the object. Hitting `?` after typing `show` will help out:

#### Example: Typing `?` after a partial command

```
OsmoMSC> show ①
  version           Displays program version
  online-help       Online help
  history           Display the session command history
  cs7               ITU-T Signaling System 7
  logging           Show current logging configuration
  alarms            Show current logging configuration
  talloc-context    Show talloc memory hierarchy
  stats             Show statistical values
  asciidoc          AsciiDoc generation
  rate-counters     Show all rate counters
  fsm               Show information about finite state machines
  fsm-instances     Show information about finite state machine instances
  sgs-connections  Show SGS interface connections / MMEs
  subscriber        Operations on a Subscriber
  bsc               BSC
  connection        Subscriber Connections
  transaction       Transactions
  statistics         Display network statistics
  sms-queue         Display SMSqueue statistics
  smpp              SMPP Interface
```

- ① Type `?` after the `show` command, the `?` itself will not be printed.

You may pick the `bsc` object and type `?` again:

#### Example: Typing `?` after `show bsc`

```
OsmoMSC> show bsc
<cr>
```

By presenting `<cr>` as the only option, the VTY tells you that your command is complete without any remaining arguments being available, and that you should hit enter, a.k.a. "carriage return".

### 12.3.2 TAB completion

The VTY supports tab (tabulator) completion. Simply type any partial command and press `<tab>`, and it will either show you a list of possible expansions, or completes the command if there's only one choice.

#### Example: Use of `<tab>` pressed after typing only `s` as command

```
OsmoMSC> s ①
show      sms      subscriber
```

- ① Type `<tab>` here.

At this point, you may choose `show`, and then press `<tab>` again:

#### Example: Use of `<tab>` pressed after typing `show` command

```
OsmoMSC> show ❶
version      online-help history      cs7          logging      alarms
talloc-context stats      asciidoc     rate-counters fsm          fsm-instances
sgs-connections subscriber bsc          connection transaction statistics
sms-queue smpp
```

❶ Type <tab> here.

### 12.3.3 The list command

The `list` command will give you a full list of all commands and their arguments available at the current node:

#### Example: Typing list at start of OsmoMSC VIEW node prompt

```
OsmoMSC> list
show version
show online-help
list
exit
help
enable
terminal length <0-512>
terminal no length
who
show history
show cs7 instance <0-15> users
show cs7 (sua|m3ua|ipa) [<0-65534>]
show cs7 instance <0-15> asp
show cs7 instance <0-15> as (active|all|m3ua|sua)
show cs7 instance <0-15> sccp addressbook
show cs7 instance <0-15> sccp users
show cs7 instance <0-15> sccp ssn <0-65535>
show cs7 instance <0-15> sccp connections
show cs7 instance <0-15> sccp timers
logging enable
logging disable
logging filter all (0|1)
logging color (0|1)
logging timestamp (0|1)
logging print extended-timestamp (0|1)
logging print category (0|1)
logging print category-hex (0|1)
logging print level (0|1)
logging print file (0|1|basename) [last]
logging set-log-mask MASK
logging level (rll|cc|mm|rr|mncc|pag|msc|mgcp|ho|db|ref|ctrl|smpp|ranap|vlr|iucs|bssap| ←
sgs|lglobal|llapd|linp|lmux|lmi|lmib|lsms|lctrl|lgtpl|lstats|lgsup|loap|lss7|lsccp|lsua ←
|lm3ua|lmgcp|ljibuf|lrspro) (debug|info|notice|error|fatal)
logging level set-all (debug|info|notice|error|fatal)
logging level force-all (debug|info|notice|error|fatal)
no logging level force-all
show logging vty
show alarms
show talloc-context (application|all) (full|brief|DEPTH)
show talloc-context (application|all) (full|brief|DEPTH) tree ADDRESS
show talloc-context (application|all) (full|brief|DEPTH) filter REGEXP
show stats
show stats level (global|peer|subscriber)
show asciidoc counters
show rate-counters
```

```

show fsm NAME
show fsm all
show fsm-instances NAME
show fsm-instances all
show sgs-connections
show subscriber (msisdn|extension|imsi|tmsi|id) ID
show subscriber cache
show bsc
show connection
show transaction
sms send pending
sms delete expired
subscriber create imsi ID
subscriber (msisdn|extension|imsi|tmsi|id) ID sms sender (msisdn|extension|imsi|tmsi|id) ←
    SENDER_ID send .LINE
subscriber (msisdn|extension|imsi|tmsi|id) ID silent-sms sender (msisdn|extension|imsi| ←
    tmsi|id) SENDER_ID send .LINE
subscriber (msisdn|extension|imsi|tmsi|id) ID silent-call start (any|tch/f|tch/any|sdcc)
subscriber (msisdn|extension|imsi|tmsi|id) ID silent-call stop
subscriber (msisdn|extension|imsi|tmsi|id) ID ussd-notify (0|1|2) .TEXT
subscriber (msisdn|extension|imsi|tmsi|id) ID ms-test close-loop (a|b|c|d|e|f|i)
subscriber (msisdn|extension|imsi|tmsi|id) ID ms-test open-loop
subscriber (msisdn|extension|imsi|tmsi|id) ID paging
show statistics
show sms-queue
logging filter imsi IMSI
show smpp esme

```

**Tip**

Remember, the list of available commands will change significantly depending on the Osmocom program you are accessing, its software version and the current node you're at. Compare the above example of the OsmoMSC *VIEW* node with the list of the OsmoMSC *NETWORK* config node:

**Example: Typing list at start of OsmoMSC NETWORK config node prompt**

```

OsmoMSC(config-net)# list
help
list
write terminal
write file
write memory
write
show running-config
exit
end
network country code <1-999>
mobile network code <0-999>
short name NAME
long name NAME
encryption a5 <0-3> [<0-3>] [<0-3>] [<0-3>]
authentication (optional|required)
rrlp mode (none|ms-based|ms-preferred|ass-preferred)
mm info (0|1)
timezone <-19-19> (0|15|30|45)
timezone <-19-19> (0|15|30|45) <0-2>
no timezone
periodic location update <6-1530>
no periodic location update

```

### 12.3.4 The attribute system

The VTY allows to edit the configuration at runtime. For many VTY commands the configuration change is immediately valid but for some commands a change becomes valid on a certain event only. In some cases it is even necessary to restart the whole process.

To give the user an overview, which configuration change applies when, the VTY implements a system of attribute flags, which can be displayed using the `show` command with the parameter `vtty-attributes`

#### Example: Typing `show vty-attributes` at the VTY prompt

```
OsmoBSC> show vty-attributes
Global attributes:
  ^ This command is hidden (check expert mode)
  ! This command applies immediately
  @ This command applies on VTY node exit
Library specific attributes:
  A This command applies on ASP restart
  I This command applies on IPA link establishment
  L This command applies on E1 line update
Application specific attributes:
  o This command applies on A-bis OML link (re)establishment
  r This command applies on A-bis RSL link (re)establishment
  l This command applies for newly created lchans
```

The attributes are symbolized through a single ASCII letter (flag) and do exist in three levels. This is more or less due to the technical aspects of the VTY implementation. For the user, the level of an attribute has only informative purpose.

The global attributes, which can be found under the same attribute letter in every osmocom application, exist on the top level. The Library specific attributes below are used in various osmocom libraries. Like with the global attributes the attribute flag letter stays the same throughout every osmocom application here as well. On the third level one can find the application specific attributes. Those are unique to each osmocom application and the attribute letters may have different meanings in different osmocom applications. To make the user more aware of this, lowercase letters were used as attribute flags.

The `list` command with the parameter `with-flags` displays a list of available commands on the current VTY node, along with attribute columns on the left side. Those columns contain the attribute flag letters to indicate to the user how the command behaves in terms of how and when the configuration change takes effect.

#### Example: Typing `list with-flags` at the VTY prompt

```
OsmoBSC(config-net-bts)# list with-flags
. ... help
. ... list [with-flags]
. ... show vty-attributes
. ... show vty-attributes (application|library|global)
. ... write terminal
. ... write file [PATH]
. ... write memory
. ... write
. ... show running-config ❶
. ... exit
. ... end
. o.. type (unknown|bs11|nanobts|rbs2000|nokia_site|sysmobts) ❷
. ... description .TEXT
. ... no description
. o.. band BAND
. .r. cell_identity <0-65535> ❸
. .r. dtx uplink [force]
. .r. dtx downlink
. .r. no dtx uplink
. .r. no dtx downlink
. .r. location_area_code <0-65535>
. o.. base_station_id_code <0-63>
```

```

. o.. ipa unit-id <0-65534> <0-255>
. o.. ipa rsl-ip A.B.C.D
. o.. nokia_site skip-reset (0|1)
! ... nokia_site no-local-rel-conf (0|1) ④
! ... nokia_site bts-reset-timer <15-100> ⑤

```

- ① This command has no attributes assigned.
- ② This command applies on A-bis OML link (re)establishment.
- ③ This command applies on A-bis RSL link (re)establishment.
- ④, ⑤ This command applies immediately.

There are multiple columns because a single command may be associated with multiple attributes at the same time. To improve readability each flag letter gets a dedicated column. Empty spaces in the column are marked with a dot (".")

In some cases the listing will contain commands that are associated with no flags at all. Those commands either play an exceptional role (interactive commands outside "configure terminal", vty node navigation commands, commands to show / write the config file) or will require a full restart of the overall process to take effect.

### 12.3.5 The expert mode

Some VTY commands are considered relatively dangerous if used in production operation, so the general approach is to hide them. This means that they don't show up anywhere but the source code, but can still be executed. On the one hand, this approach reduces the risk of an accidental invocation and potential service degradation; on the other, it complicates intentional use of the hidden commands.

The VTY features so-called *expert* mode, that makes the hidden commands appear in the interactive help, as well as in the XML VTY reference, just like normal ones. This mode can be activated from the *VIEW* node by invoking the `enable` command with the parameter `expert-mode`. It remains active for the individual VTY session, and gets disabled automatically when the user switches back to the *VIEW* node or terminates the session.

A special attribute in the output of the `list with-flags` command indicates whether a given command is hidden in normal mode, or is a regular command:

#### Example: Hidden commands in the output of the `list with-flags` command

```

OsmoBSC> enable expert-mode ①
OsmoBSC# list with-flags
...
^ bts <0-255> (activate-all-lchan|deactivate-all-lchan) ②
^ bts <0-255> trx <0-255> (activate-all-lchan|deactivate-all-lchan) ③
. bts <0-255> trx <0-255> timeslot <0-7> sub-slot <0-7> mdcx A.B.C.D <0-65535> ④
^ bts <0-255> trx <0-255> timeslot <0-7> sub-slot <0-7> (borken|unused) ⑤
. bts <0-255> trx <0-255> timeslot <0-7> sub-slot <0-7> handover <0-255> ⑥
. bts <0-255> trx <0-255> timeslot <0-7> sub-slot <0-7> assignment ⑦
. bts <0-255> smscb-command (normal|schedule|default) <1-4> HEXSTRING ⑧
...

```

- ① This command enables the *expert* mode.
- ②, ③, ⑤ This is a hidden command (only shown in the *expert* mode).
- ④, ⑥, ⑦, ⑧ This is a regular command that is always shown regardless of the mode.

## 13 libosmocore Logging System

In any reasonably complex software it is important to understand how to enable and configure logging in order to get a better insight into what is happening, and to be able to follow the course of action. We therefore ask the reader to bear with us while we explain how the logging subsystem works and how it is configured.

Most Osmocom Software (like `osmo-bts`, `osmo-bsc`, `osmo-nitb`, `osmo-sgsn` and many others) uses the same common logging system.

This chapter describes the architecture and configuration of this common logging system.

The logging system is composed of

- log targets (where to log),
- log categories (who is creating the log line),
- log levels (controlling the verbosity of logging), and
- log filters (filtering or suppressing certain messages).

All logging is done in human-readable ASCII-text. The logging system is configured by means of VTY commands that can either be entered interactively, or read from a configuration file at process start time.

### 13.1 Log categories

Each sub-system of the program in question typically logs its messages as a different category, allowing fine-grained control over which log messages you will or will not see. For example, in OsmoBSC, there are categories for the protocol layers `rsl`, `rr`, `mm`, `cc` and many others. To get a list of categories interactively on the vty, type: `logging level ?`

### 13.2 Log levels

For each of the log categories (see Section 13.1), you can set an independent log level, controlling the level of verbosity. Log levels include:

#### **fatal**

Fatal messages, causing abort and/or re-start of a process. This *shouldn't happen*.

#### **error**

An actual error has occurred, its cause should be further investigated by the administrator.

#### **notice**

A noticeable event has occurred, which is not considered to be an error.

#### **info**

Some information about normal/regular system activity is provided.

#### **debug**

Verbose information about internal processing of the system, used for debugging purpose. This will log the most.

The log levels are inclusive, e.g. if you select *info*, then this really means that all events with a level of at least *info* will be logged, i.e. including events of *notice*, *error* and *fatal*.

So for example, in OsmoBSC, to set the log level of the Mobility Management category to *info*, you can use the following command: `log level mm info`.

There is also a special command to set all categories as a one-off to a desired log level. For example, to silence all messages but those logged as *notice* and above issue the command: `log level set-all notice`



Afterwards you can adjust specific categories as usual.

A similar command is `log level force-all <level>` which causes all categories to behave as if set to log level `<level>` until the command is reverted with `no log level force-all` after which the individually-configured log levels will again take effect. The difference between `set-all` and `force-all` is that `set-all` actually changes the individual category settings while `force-all` is a (temporary) override of those settings and does not change them.

### 13.3 Log printing options

The logging system has various options to change the information displayed in the log message.

#### **log color 1**

With this option each log message will log with the color of its category. The color is hard-coded and can not be changed. As with other options a `0` disables this functionality.

#### **log timestamp 1**

Includes the current time in the log message. When logging to syslog this option should not be needed, but may come in handy when debugging an issue while logging to file.

#### **log print extended-timestamp 1**

In order to debug time-critical issues this option will print a timestamp with millisecond granularity.

#### **log print category 1**

Prefix each log message with the category name.

#### **log print category-hex 1**

Prefix each log message with the category number in hex (`<000b>`).

#### **log print level 1**

Prefix each log message with the name of the log level.

#### **log print file 1**

Prefix each log message with the source file and line number. Append the keyword `last` to append the file information instead of prefixing it.

### 13.4 Log filters

The default behavior is to filter out everything, i.e. not to log anything. The reason is quite simple: On a busy production setup, logging all events for a given subsystem may very quickly be flooding your console before you have a chance to set a more restrictive filter.

To request no filtering, i.e. see all messages, you may use: `log filter all 1`

In addition to generic filtering, applications can implement special log filters using the same framework to filter on particular context.

For example in OsmoBSC, to only see messages relating to a particular subscriber identified by his IMSI, you may use: `log filter imsi 262020123456789`

### 13.5 Log targets

Each of the log targets represent certain destination for log messages. It can be configured independently by selecting levels (see Section 13.2) for categories (see Section 13.1) as well as filtering (see Section 13.4) and other options like `logging timestamp` for example.

### 13.5.1 Logging to the VTY

Logging messages to the interactive command-line interface (VTY) is most useful for occasional investigation by the system administrator.

Logging to the VTY is disabled by default, and needs to be enabled explicitly for each such session. This means that multiple concurrent VTY sessions each have their own logging configuration. Once you close a VTY session, the log target will be destroyed and your log settings be lost. If you re-connect to the VTY, you have to again activate and configure logging, if you wish.

To create a logging target bound to a VTY, you have to use the following command: `logging enable` This doesn't really activate the generation of any output messages yet, it merely creates and attaches a log target to the VTY session. The newly-created target still doesn't have any filter installed, i.e. *all log messages will be suppressed by default*

Next, you can configure the log levels for desired categories in your VTY session. See Section 13.1 for more details on categories and Section 13.2 for the log level details.

For example, to set the log level of the Call Control category to debug, you can use: `log level cc debug`

Finally, after having configured the levels, you still need to set the filter as it's described in Section 13.4.

---

#### Tip

If many messages are being logged to a VTY session, it may be hard to impossible to still use the same session for any commands. We therefore recommend to open a second VTY session in parallel, and use one only for logging, while the other is used for interacting with the system. Another option would be to use different log target.

---

To review the current vty logging configuration, you can use: `show logging vty`

### 13.5.2 Logging to the ring buffer

To avoid having separate VTY session just for logging output while still having immediate access to them, one can use `alarms` target. It lets you store the log messages inside the ring buffer of a given size which is available with `show alarms` command.

It's configured as follows:

```
OsmoBSC> enable
OsmoBSC# configure terminal
OsmoBSC(config)# log alarms 98
OsmoBSC(config-log)#
```

In the example above 98 is the desired size of the ring buffer (number of messages). Once it's filled, the incoming log messages will push out the oldest messages available in the buffer.

### 13.5.3 Logging via gsmtap

GSMTAP is normally a pseudo-header format that enables the IP-transport of GSM (or other telecom) protocols that are not normally transported over IP. For example, the most common situation is to enable GSMTAP in OsmoBTS or OsmoPCU to provide GSM-Um air interface capture files over IP, so they can be analyzed in Wireshark.

GSMTAP logging is now a method how Osmocom software can also encapsulate its own log output in GSMTAP frames. We're not trying to re-invent rsyslog here, but this is very handy when debugging complex issues. It enables the reader of the pcap file containing GSMTAP logging together with other protocol traces to reconstruct exact chain of events. A single pcap file can then contain both the log output of any number of Osmocom programs in the same timeline of the messages on various interfaces in and out of said Osmocom programs.

It's configured as follows:

```
OsmoBSC> enable
OsmoBSC# configure terminal
OsmoBSC(config)# log gsmtap 192.168.2.3
OsmoBSC(config-log)#
```

The hostname/ip argument is optional: if omitted the default 127.0.0.1 will be used. The log strings inside GSMTAP are already supported by Wireshark. Capturing for port 4729 on appropriate interface will reveal log messages including source file name and line number as well as application. This makes it easy to consolidate logs from several different network components alongside the air frames. You can also use Wireshark to quickly filter logs for a given subsystem, severity, file name etc.

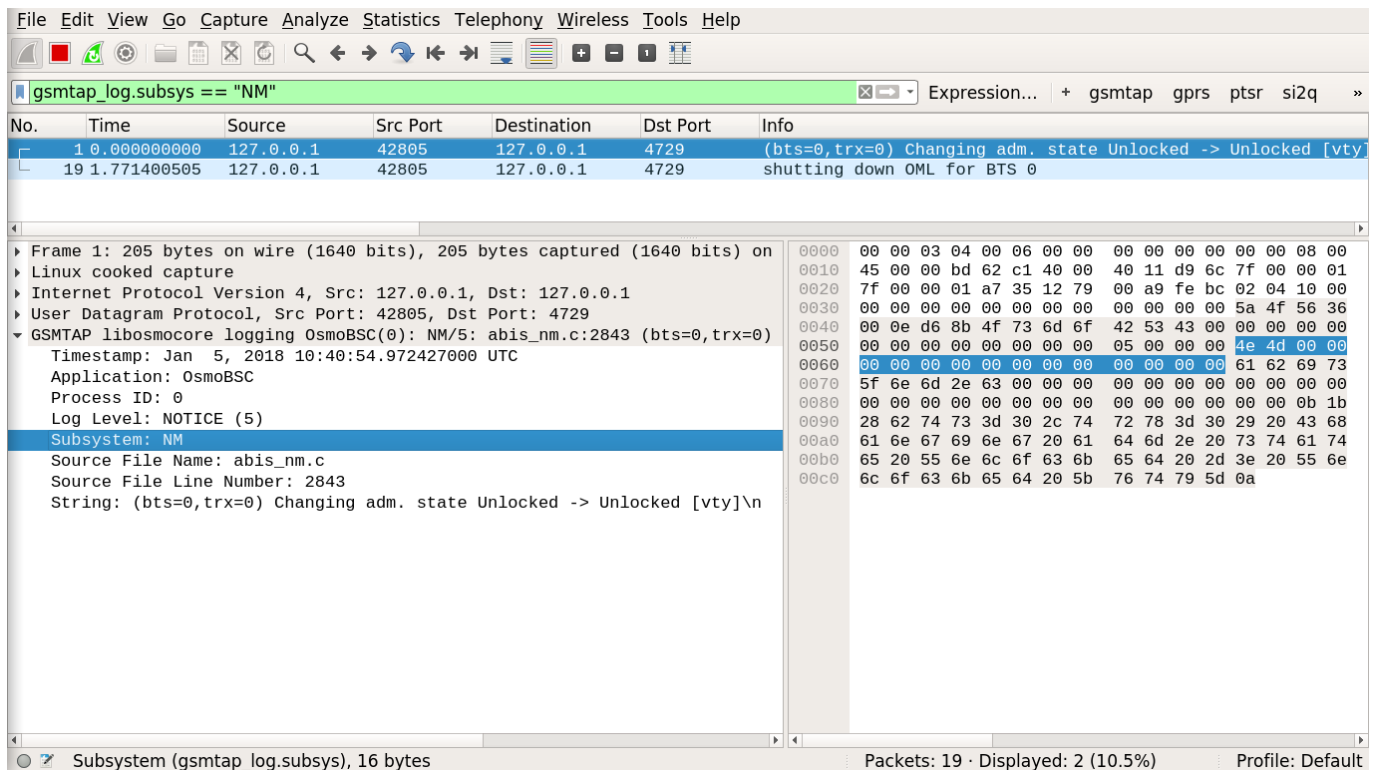

Figure 4: Wireshark with logs delivered over GSMTAP

Note: the logs are also duplicated to stderr when GSMTAP logging is configured because stderr is the default log target which is initialized automatically. To decrease stderr logging to absolute minimum, you can configure it as follows:

```
OsmoBSC> enable
OsmoBSC# configure terminal
OsmoBSC(config)# log stderr
OsmoBSC(config-log)# logging level force-all fatal
```

#### Note

Every time you generate GSMTAP messages and send it to a unicast (non-broadcast/multicast) IP address, please make sure that the destination IP address actually has a socket open on the specified port, or drops the packets in its packet filter. If unicast GSMTAP messages arrive at a closed destination UDP port, the operating system will likely generate ICMP port unreachable messages. Those ICMP messages in turn will, when arriving at the source (the host on which you run the Osmocom software sending GSMTAP), suppress generation of further GSMTAP messages for some time, resulting in incomplete files. In case of doubt, either send GSMTAP to multicast IP addresses, or run something like `nc -l -u -p 4729 > /dev/null` on the destination host to open the socket at the GSMTAP port and discard anything arriving at it.

### 13.5.4 Logging to a file

As opposed to Logging to the VTY, logging to files is persistent and stored in the configuration file. As such, it is configured in sub-nodes below the configuration node. There can be any number of log files active, each of them having different settings regarding levels / subsystems.

To configure a new log file, enter the following sequence of commands:

```
OsmoBSC> enable
OsmoBSC# configure terminal
OsmoBSC(config)# log file /path/to/my/file
OsmoBSC(config-log)#
```

This leaves you at the config-log prompt, from where you can set the detailed configuration for this log file. The available commands at this point are identical to configuring logging on the VTY, they include `logging filter`, `logging level` as well as `logging color` and `logging timestamp`.

---

**Tip**

Don't forget to use the `copy running-config startup-config` (or its short-hand `write file`) command to make your logging configuration persistent across application re-start.

---

**Note**

libsmocore provides file close-and-reopen support by `SIGHUP`, as used by popular log file rotating solutions such as <https://github.com/logrotate/logrotate> found in most GNU/Linux distributions.

---

### 13.5.5 Logging to syslog

syslog is a standard for computer data logging maintained by the IETF. Unix-like operating systems like GNU/Linux provide several syslog compatible log daemons that receive log messages generated by application programs.

libsmocore based applications can log messages to syslog by using the `syslog` log target. You can configure syslog logging by issuing the following commands on the VTY:

```
OsmoBSC> enable
OsmoBSC# configure terminal
OsmoBSC(config)# log syslog daemon
OsmoBSC(config-log)#
```

This leaves you at the config-log prompt, from where you can set the detailed configuration for this log file. The available commands at this point are identical to configuring logging on the VTY, they include `logging filter`, `logging level` as well as `logging color` and `logging timestamp`.

---

**Note**

Syslog daemons will normally automatically prefix every message with a time-stamp, so you should disable the libsmocore time-stamping by issuing the `logging timestamp 0` command.

---

### 13.5.6 Logging to systemd-journal

systemd has been adopted by the majority of modern GNU/Linux distributions. Along with various daemons and utilities it provides `systemd-journald` [1] - a daemon responsible for event logging (syslog replacement). libsmocore based applications can log messages directly to `systemd-journald`.

The key difference from other logging targets is that systemd based logging allows to offload rendering of the meta information, such as location (file name, line number), subsystem, and logging level, to `systemd-journald`. Furthermore, systemd allows to attach arbitrary meta fields to the logging messages [2], which can be used for advanced log filtering.

[1] <https://www.freedesktop.org/software/systemd/man/systemd-journald.service.html> [2] <https://www.freedesktop.org/software/systemd/man/systemd.journal-fields.html>

It was decided to introduce libsystemd as an optional dependency, so it needs to be enabled explicitly at configure/build time:

```
$ ./configure --enable-systemd-logging
```

---

#### Note

Recent libosmocore packages provided by Osmocom for Debian and CentOS are compiled **with** systemd (<https://gerrit.osmocom.org/c/libosmocore/+22651>).

---

You can configure systemd based logging in two ways:

#### Example: systemd-journal target with offloaded rendering

```
log systemd-journal raw ❶
logging filter all 1
logging level set-all notice
```

- ❶ raw logging handler, rendering offloaded to systemd.

In this example, logging messages will be passed to systemd without any meta information (time, location, level, category) in the text itself, so all the printing parameters like `logging print file` will be ignored. Instead, the meta information is passed separately as *fields* which can be retrieved from the journal and rendered in any preferred way.

```
# Show Osmocom specific fields
$ journalctl --fields | grep OSMO

# Filter messages by logging subsystem at run-time
$ journalctl OSMO_SUBSYS=DMSC -f

# Render specific fields only
$ journalctl --output=verbose \
  --output-fields=SYSLOG_IDENTIFIER,OSMO_SUBSYS,CODE_FILE,CODE_LINE,MESSAGE
```

See `man 7 systemd.journal-fields` for a list of default fields, and `man 1 journalctl` for general information and available formatters.

#### Example: systemd-journal target with libosmocore based rendering

```
log systemd-journal ❶
logging filter all 1
logging print file basename
logging print category-hex 0
logging print category 1
logging print level 1
logging timestamp 0 ❷
logging color 1 ❸
logging level set-all notice
```

- ❶ Generic logging handler, rendering is done by libosmocore.
- ❷ Disable timestamping, systemd will timestamp every message anyway.
- ❸ Colored messages can be rendered with `journalctl --output=cat`.

In this example, logging messages will be pre-processed by libosmocore before being passed to systemd. No additional fields will be attached, except the logging level (PRIORITY). This mode is similar to *syslog* and *stderr*.

### 13.5.7 Logging to stderr

If you're not running the respective application as a daemon in the background, you can also use the stderr log target in order to log to the standard error file descriptor of the process.

In order to configure logging to stderr, you can use the following commands:

```
OsmoBSC> enable
OsmoBSC# configure terminal
OsmoBSC(config)# log stderr
OsmoBSC(config-log)#
```

## 14 BTS Configuration

The role of the BTS is to handle the GSM radio interface. When the BTS application is starting, the A-bis OML connection is established towards the BSC. Almost all BTS configuration (such as ARFCN, channel configuration, transmit power, etc.) will be sent from the BSC to the BTS via OML messages. After OML start-up has completed, the BSC will instruct the BTS to establish the RSL connections.

Given that most configuration is downloaded from the BSC into the BTS at start-up time, only some very basic settings have to be made in the OsmoBTS software.

### 14.1 Command Line Options

The OsmoBTS executables (`osmo-bts-sysmo`, `osmo-bts-trx`, `osmo-bts-octphy`, `osmo-bts-litecell115`, ...) share the following generic command line options:

#### 14.1.1 SYNOPSIS

```
osmo-bts-sysmo [-hl-V] [-d DBGMASK] [-D] [-c CONFIGFILE] [-s] [-T] [-e LOGLEVEL]
```

#### 14.1.2 OPTIONS

**-h, --help**

Print a short help message about the supported options

**-V, --version**

Print the compile-time version number of the OsmoBTS program

**-d, --debug *DBGMASK,DBGLEVELS***

Set the log subsystems and levels for logging to stderr. This has mostly been superseded by VTY-based logging configuration, see Section 13 for further information.

**-D, --daemonize**

Fork the process as a daemon into background.

**-c, --config-file *CONFIGFILE***

Specify the file and path name of the configuration file to be used. If none is specified, use `osmo-bts.cfg` in the current working directory.

**-s, --disable-color**

Disable colors for logging to stderr. This has mostly been deprecated by VTY based logging configuration, see Section 13 for further information.

**-T, --timestamp**

Enable time-stamping of log messages to stderr. This has mostly been deprecated by VTY based logging configuration, see Section 13 for further information.

**-e, --log-level *LOGLEVEL***

Set the global log level for logging to stderr. This has mostly been deprecated by VTY based logging configuration, see Section 13 for further information.

There may be additional, hardware specific command line options by the different `bts_model` implementations.

## 14.2 Configuration using the VTY

Most configuration as well as run-time monitoring and system introspection is implemented using a command-line based interface called *VTY*. A full reference syntax of all existing VTY command is available as a separate document.

See Section 12 for further information on the VTY.

### 14.2.1 Required BTS/TRX configuration

There are some settings that have to be configured locally in the `sysmoBTS`, as they cannot be set remotely from the BSC. Those settings are stored in the OsmoBTS configuration file, which commonly is stored in `/etc/osmocom/osmo-bts.cfg`.

#### Example Minimal configuration file

```
!
! OsmoBTS (0.0.1.100-0455) configuration saved from vty
!!
!
phy 0 ❶
  instance 0 ❷
bts 0 ❸
  band DCS1800
  ipa unit-id 1801 0 ❹
  oml remote-ip 192.168.100.11 ❺
  trx 0 ❻
    phy 0 instance 0 ❼
```

- ❶ You must configure at least one PHY link by means of the PHY node
- ❷ You must configure at least one PHY instance in the PHY link
- ❸ There is always exactly one BTS (`bts 0`) configured in OsmoBTS
- ❹ The `ipa unit-id` is what is used to identify this BTS to the BSC
- ❺ The OML Remote IP is the IP address of the BSC, to which the BTS shall connect to.
- ❻ There must be at least one `trx 0` in each BTS
- ❼ Every TRX must be mapped to a specific PHY instance this way

For a full reference of all available VTY configuration parameters, please refer to the OsmoBTS VTY Reference document.

### 14.2.2 Configuring GSMTAP tracing

In addition to being able to obtain pcap protocol traces of the A-bis communication and the text-based logging from the OsmoBTS software, there is also the capability of tracing all communication on the radio interface. To do so, OsmoBTS can encapsulate MAC blocks (23byte messages at the L2-L1 interface) into *GSMTAP* and send them via UDP/IP. At that point, they can be captured with utilities like **tcpdump** or **tshark** for further analysis by the **wireshark** protocol analyzer.

In order to activate this feature, you first need to make sure to specify the remote address of *GSMTAP* host in the configuration file. In most cases, using 127.0.0.1 for passing the messages over the loopback (lo) device will be sufficient:

#### Example: Enabling GSMTAP Um-frame logging to localhost

```
bts 0
  gsmtap-remote-host 127.0.0.1 ❶
```

- ❶ Destination address for *GSMTAP* Um-frames

---

#### Note

Changing this parameter at run-time will not affect the existing *GSMTAP* connection, full program restart is required.

---

#### Note

Command line parameters `-i` and `--gsmtap-ip` have been deprecated.

---

OsmoBTS can selectively trace such messages by their L1 SAPI, for both Rx and Tx. For a complete list of L1 SAPI values, please refer to the *OsmoBTS VTY reference manual* [[vty-ref-osmobts](#)].

For example, to enable GSMTAP tracing for messages on all SDCCH channels, you can use the `gsmtap-sapi sdcch` command at the CONFIG TRX node of the OsmoBTS VTY.

#### Example: Enabling GSMTAP for SDCCH

```
OsmoBTS> enable
OsmoBTS# configure terminal
OsmoBTS(config)# bts 0
OsmoBTS(bts)# gsmtap-sapi sdcch
OsmoBTS(trx)# write ❶
```

- ❶ the `write` command will make the configuration persistent in the configuration file. This is not required if you wish to enable GSMTAP only in the current session of OsmoBTS.

De-activation can be performed similarly by using the `no gsmtap-sapi sdcch` command at the `bts` node of the OsmoBTS VTY.

It may be useful to enable all SAPIs with a few exceptions, or vice versa disable everything using one command. For this purpose, the VTY provides `gsmtap-sapi enable-all` and `gsmtap-sapi disable-all` commands.

#### Example: Enabling all SAPIs except PDTCH and PTCCH

```
bts 0
  gsmtap-sapi enable-all ❶
  no gsmtap-sapi pdtch ❷
  no gsmtap-sapi ptcch ❸
```

- ❶ Enable all available SAPIs
- ❷, ❸ Exclude PDTCH and PTCCH SAPIs

From the moment they are enabled via VTY, GSMTAP messages will be generated and sent in UDP encapsulation to the IANA-registered UDP port for GSMTAP (4729) of the specified remote address.



### 14.2.3 Configuring power ramping

OsmoBTS can ramp up the power of its trx over time. This helps reduce cell congestion in busy environments.

Some models of OsmoBTS (such as osmo-bts-trx) also support ramping down the transmit power over time until finally ceasing broadcast, for instance due to a trx becoming administratively locked or due to the whole BTS being gracefully shut down. This allows for mobile stations camping on the cell to gradually move to other cells in the area once the signal drop is detected.

In this example, the trx starts with 5dBm output power which increases by 1dB every two seconds until it reaches nominal power. Power ramping can use the power-ramp commands at the CONFIG TRX node of the OsmoBTS VTY.

#### Example: Configure power ramping on trx 0

```
OsmoBTS> enable
OsmoBTS# configure terminal
OsmoBTS(config)# bts 0
OsmoBTS(bts)# trx 0
OsmoBTS(trx)# power-ramp max-initial 5 dBm
OsmoBTS(trx)# power-ramp step-size 1 dB
OsmoBTS(trx)# power-ramp step-interval 2
OsmoBTS(trx)# write ❶
```

❶ the write command will make the configuration persistent in the configuration file.

De-activating power-ramping can be performed by setting the max-initial value to the nominal power. The default max-initial value is 23 dBm.

### 14.2.4 Running multiple instances

It is possible to run multiple instances of osmo-bts on one and the same machine, if the phy-interface is flexible enough to distinguish between different phy hardware interfaces.

Since usually a BTS instance runs in conjunction with a dedicated PCU instance, the socket path between PCU and BTS has to be distinguished between the running instances. It is possible to change the default socket path via VTY config:

#### Example: Personalize PCU socket path

```
bts 0
pcu-socket /tmp/pcu_bts_2
```

It is also necessary to separate the VTY and CTRL interfaces of the different instances. The VTY, as well as the CTRL interface can be bound to a free IP address from the loopback range:

#### Example: Binding VTY and CTRL interface to a specific IP address

```
line vty
bind 127.0.0.2
ctrl
bind 127.0.0.2
```

## 15 Support for Dynamic Timeslots (TCH/F, TCH/H, PDCH)

OsmoBTS supports dynamic switchover of timeslots between different physical channel configurations, initiated by the BSC via (non-standard) Abis messages — see the *OsmoBTS Abis Protocol Specification* [osmobts-abis-spec].

The Abis message handling for dynamic timeslots is independent of the BTS model. However, dynamic switchover will only work for BTS models that implement the internal API to reconnect a timeslot (*bts\_model\_ts\_disconnect()* and *bts\_model\_ts\_connect()*), see also Section 16).

Currently, these OsmoBTS models support dynamic timeslots:

- *osmo-bts-sysmo*
- *osmo-bts-litecell15*
- *osmo-bts-trx*

Dynamic timeslots are driven by the BSC and need to be configured there. When using OsmoBSC or OsmoNITB, see the BTS configuration chapter on dynamic timeslots in [\[userman-osmobsc\]](#) or [\[userman-osmonitb\]](#), respectively.

## 16 OsmoBTS hardware support

OsmoBTS consists of a *common* part that applies to all BTS models as well as *hardware-specific* parts for each BTS model. The hardware specific parts are generally referred to as the *bts\_model* code.

The common part includes the core BTS architecture as well as code for implementing the external interfaces such as Abis, control, PCU socket and GSMTAP.

The *bts\_model* parts include support for driving one particular implementation of a GSM physical layer (PHY). Such a physical layer implementation can come in many forms. Sometimes it runs on a general purpose CPU, sometimes on a dedicated ARM core, a dedicated DSP, a combination of DSP and FPGA.

Every PHY implementation offers some kind of primitives by which the PHY can be controlled, and by which the PHY exchanges data with the higher layers of the protocol stack in the OsmoBTS code.

The PHY-specific primitives are encapsulated in the *bts\_model* code, and offered as a PHY-independent *LISAP* interface towards the common part of OsmoBTS.

In addition, each *bts\_model* implements a set of functions that the common part calls. Those functions are pre-fixed by *bts\_model\_*.

Each *bts\_model* may offer

- model-specific VTY commands for both configuration and run-time interaction
- model-specific command line arguments
- model-specific control interface commands

## 17 *osmo-bts-sysmo* for sysmocom sysmoBTS

The sysmocom sysmoBTS is a range of GSM BTSs based around an embedded system implementing the PHY in a combination of DSP+FPGA. The PHY is configured by a set of primitives described by header files. Those primitives are exchanged over a set of message queues exposed on the Linux-running ARM core via device nodes in `/dev/msgq/`. Internally, the message queues map to shared memory between the Linux-running ARM core and the DSP running the PHY implementation.

The OsmoBTS *bts\_model* code for the sysmoBTS can be found in the `src/osmo-bts-sysmo` sub-directory of the OsmoBTS code base.

`osmo-bts-sysmo` has been the primary target platform for OsmoBTS for many years and is thus the most feature-complete and mature platform supported by OsmoBTS at this point.

The sysmoBTS PHY supports a direct PHY interface to OsmoPCU, reducing the latency and amount of primitives that OsmoBTS would otherwise need to pass through from the PHY message queues to the PCU socket and vice-versa.

## 17.1 osmo-bts-sysmo specific command line arguments

### **--dsp-trace *DSPMASK***

Set the DSP trace flags (a single hexadecimal 32bit value). This has been deprecated by VTY based commands, see Section 17.2.1.2 for further information.

### **--pcu-direct**

Indicate that an external PCU (e.g. OsmoPCU) will directly open the DSP message queues to the PHY / PH-SAP, and only MPH primitives are passed via OsmoBTS.

## 17.2 osmo-bts-sysmo specific VTY commands

For a auto-generated complete syntax reference of the VTY commands, please see the associated *OsmoBTS VTY reference manual* [[vty-ref-osmobts](#)]. The section below only lists the most important commands.

### 17.2.1 at the *SHOW* node

#### 17.2.1.1 **show trx 0 clock-source**

Display the currently active clock source configuration for the TRX

#### 17.2.1.2 **show trx 0 dsp-trace-flags**

Show the currently active DSP trace flags for the TRX

#### 17.2.1.3 **trx 0 dsp-trace-flag**

Use this command to enable/disable/configure the DSP tracing flags that define what debug messages will appear on `/dev/rtfifo/ds`

### 17.2.2 at the *ENABLE* node

#### 17.2.2.1 **trx 0 tx-power <-110-100>**

Change the current TRX transmit power to the given value in dBm.

#### 17.2.2.2 **trx 0 rf-clock-info reset**

Part of the clock calibration procedure: Reset the clock correction value.

#### 17.2.2.3 **trx 0 rf-clock-info correct**

Part of the clock calibration procedure: Apply the current measured correction value between the reference clock and the local clock.

### 17.2.3 at the *PHY instance* node

#### 17.2.4 **clock-calibration eeprom**

Obtain clock calibration value from EEPROM.

### 17.2.5 `clock-calibration default`

Use hardware default clock calibration value.

### 17.2.6 `clock-calibration <-4095-4095>`

Use specified clock calibration value (not EEPROM/default).

### 17.2.7 `clock-source (tcxo|ocxo|ext|gps)`

Specify the clock source for the PHY:

#### **tcxo**

Use the TCXO. This is the default on sysmoBTS 2050.

#### **ocxo**

Use the OCXO (only valid on units equipped with OCXO). This is the default on all sysmoBTS 1002/1020/1100 and SOB-BTS.

#### **ext**

Use the external clock input.

#### **gps**

Use the clock derived from GPS. You shouldn't use this clock directly, but rather use the TCXO and regularly re-calibrate against GPS.

### 17.2.8 `trx-calibration-path PATH`

Use calibration files from the given *PATH*, rather than calibration values from the EEPROM.

## 17.3 `osmo-bts-sysmo` specific control interface commands

### 17.3.1 `trx.0.clock-info`

Obtain information on the current clock status:

```
bsc_control.py -d localhost -p 4238 -g trx.0.clock-info
Got message: GET_REPLY 1 trx.0.clock-info -100,ocxo,0,0,gps
```

which is to be interpreted as:

- current clock correction value is -100 ppb
- current clock source is OCXO
- deviation between clock source and calibration source is 0 ppb
- resolution of clock error measurement is 0 ppt (0 means no result yet)
- current calibration source is GPS

When this attribute is set, any value passed on is discarded, but the clock calibration process is re-started.

### 17.3.2 `trx.0.clock-correction`

This attribute can get and set the current clock correction value:

```
bsc_control.py -d localhost -p 4238 -g trx.0.clock-correction
Got message: GET_REPLY 1 trx.0.clock-correction -100
```

```
bsc_control.py -d localhost -p 4238 -s trx.0.clock-correction -- -99
Got message: SET_REPLY 1 trx.0.clock-correction success
```

## 18 `osmo-bts-trx` for OsmoTRX

OsmoTRX is a C-language implementation of the GSM radio modem, originally developed as the *Transceiver* part of OpenBTS. This radio modem offers an interface based on top of UDP streams.

The OsmoBTS `bts_model` code for OsmoTRX is called `osmo-bts-trx`. It implements the UDP stream interface of OsmoTRX, so both parts can be used together to implement a complete GSM BTS based on general-purpose computing SDR.

As OsmoTRX is general-purpose software running on top of Linux, it is thus not tied to any specific physical hardware. At the time of this writing, OsmoTRX supports a variety of Lime Microsystems and Ettus USRP SDRs via the UHD driver, as well as the Fairwaves UmTRX and derived products.

OsmoTRX is not a complete GSM PHY but *just* the radio modem. This means that all of the Layer 1 functionality such as scheduling, convolutional coding, etc. is actually also implemented inside OsmoBTS.

As such, the boundary between OsmoTRX and `osmo-bts-trx` is at a much lower interface, which is an internal interface of other more traditional GSM PHY implementations.

Besides OsmoTRX, there are also other implementations (both Free Software and proprietary) that implement the same UDP stream based radio modem interface.

### 18.1 `osmo-bts-trx` specific VTY commands

For a auto-generated complete syntax reference of the VTY commands, please see the associated *OsmoBTS VTY reference manual* [[vty-ref-osmobts](#)]. The section below only lists the most important commands.

#### 18.1.1 at the *SHOW* node

##### 18.1.1.1 `show transceivers`

Display information about configured/connected OsmoTRX transceivers in human-readable format to current VTY session.

#### 18.1.2 at the *PHY* configuration node

##### 18.1.2.1 `osmotrx ip HOST`

Set the IP address for the OsmoTRX interface for both the local (OsmoBTS) and remote (OsmoTRX) side of the UDP flows. This option has been deprecated by the more detailed option `osmotrx ip (local|remote) A.B.C.D`.

##### 18.1.2.2 `osmotrx ip (local|remote) A.B.C.D`

Set the IP address for the OsmoTRX interface for either the local (OsmoBTS) or remote (OsmoTRX) side of the UDP flows.

### 18.1.2.3 `osmotrx base-port (local|remote) <0-65535>`

Configure the base UDP port for the OsmoTRX interface for either the local (OsmoBTS) or remote (OsmoTRX) side of the UDP flows.

### 18.1.2.4 `osmotrx fn-advance <0-30>`

Set the number of frames to be transmitted to transceiver in advance of current GSM frame number.

GSM is a TDMA (time division multiple access) system on the radio interface. OsmoTRX is the "clock master" of that in the Osmocom implementation. It informs OsmoBTS of the current GSM frame number. However, as there is non-zero delays (UDP packet transmission delay, operating system scheduler delay on both OsmoTRX and OsmoBTS side, ...), OsmoBTS must compensate for that delay by "advancing" the clock a certain amount of time.

In other words, if OsmoTRX informs us that the current frame number is  $N$ , we advance it by `fn-advance` and transmit burst data for  $N + \text{fn-advance}$  towards OsmoTRX.

The `fn-advance` should be kept as low as possible to avoid additional delays to the user voice plane as well as to improve the performance of the control plane (LAPDm) as well as GPRS.

However, `fn-advance` must be kept sufficiently high to ensure no underruns on the OsmoTRX side.

The detailed value will depend on your underlying computer systems, operating system and related tuning parameters. Running OsmoTRX on a remote host will inevitably require a higher `fn-advance` than running it on the same machine, where the UDP packets are just passed over the loopback device.

The default value for `fn-advance` is 2 (corresponding to 9.2 milliseconds).

### 18.1.2.5 `osmotrx rts-advance <0-30>`

Set the number of frames to be requested from L1SAP in advance of current frame number and `fn-advance`.

The value specified as `rts-advance` is added to the current GSM frame number as reported by OsmoTRX **and** the `osmotrx fn-advance` in order to generate the PH-RTS.ind (ready to send indications) across the L1SAP interface inside osmo-bts. This will trigger the Layer 2 (LAPDm for the control plane, RTP for the voice plane, and OsmoPCU for GPRS) to generate a MAC block and input it into the osmo-bts-trx TDMA scheduler.

If OsmoTRX reported  $N$  as the current frame number, the actual frame number reported on L1SAP to higher layers will be computed as follows:

$$N + \text{fn-advance} + \text{rts-advance}$$

The default value of `rts-advance` is 3 (corresponding to 14 milliseconds). Do not change this unless you have a good reason!

### 18.1.2.6 `osmotrx rx-gain <0-50>`

Set the receiver gain (configured in the hardware) in dB.

### 18.1.2.7 `osmotrx tx-attenuation <0-50>`

Set the transmitter attenuation (configured in the hardware) in dB.

### 18.1.2.8 `osmotrx tx-attenuation oml`

Use the Value in the A-bis OML Attribute `MAX_POWER_REDUCTION` as transmitter attenuation.

### 18.1.3 at the *PHY Instance* configuration node

#### 18.1.3.1 `slotmask (1|0) (1|0) (1|0) (1|0) (1|0) (1|0) (1|0) (1|0)`

Configure which timeslots should be active on this TRX. Normally all timeslots are enabled, unless you are running on a cpu-constrained deeply embedded system.

#### 18.1.3.2 `osmotrx maxdly <0-31>`

Set the maximum delay for received symbols (in number of GSM symbols).

## 19 `osmo-bts-octphy` for Octasic OCTPHY-2G

The Octasic OCTPHY-2G is a GSM PHY implementation inside an Octasic proprietary 24-core DSP called OCTDSP.

This DSP has a built-in Gigabit Ethernet interface, over which it exchanges PHY-layer primitives in raw Ethernet frames with the upper layers running on another CPU attached to the same Ethernet. Those primitives are described in a set of C-language header files.

OsmoBTS implements the raw Ethernet frame based primitives as well as the associated transport protocol (OKTPKT/OCTVC1) in the `osmo-bts-octphy` `bts_model` code.

You can run the `osmo-bts-octphy` on any system connected to the same Ethernet as the OCTDSP running the OCTPHY. This can be either an embedded ARM or x86 SoM part of the OCTBTS hardware, or it can be any other Linux system attached via an Ethernet switch.

Each OCTDSP running OCTSDR-2G offers a set of primitives part of a OKTPKT session, which is mapped to an OsmoBTS PHY link. Depending on the OCTSDR-2G software version, you may create multiple software TRX by creating multiple OsmoBTS PHY instances inside that PHY link.

Multiple DSPs may exist in one circuit board, then each of the DSPs is interfaced by one OsmoBTS PHY link, and each of them may have one or more OsmoBTS PHY instances creating a Multi-TRX configuration.

## 20 `osmo-bts-litecell115` for Nutaq/Nuran LiteCell 1.5

The Nutaq/Nuran LiteCell 1.5 implements a dual-transceiver GSM BTS based on a mixed ARM/DSP/FPGA architecture. The PHY layer is implemented on DSP/FPGA and similar to that of the `sysmobts`: It exchanges primitives described in a set of C-language header files over message queues between the ARM and the DSP.

This interface is implemented in the `osmo-bts-litecell115` `bts_model` of OsmoBTS. You would run `osmo-bts-litecell115` on the ARM/Linux processor of the Litecell 1.5.

The two transceivers of the Litecell 1.5 each have their own set of DSP message queues. Each set of message queues is wrapped into one OsmoBTS PHY link, offering one OsmoBTS PHY instance.

The Litecell 1.5 PHY supports a direct PHY interface to OsmoPCU, reducing the latency and amount of primitives that OsmoBTS would otherwise need to pass through from the PHY message queues to the PCU socket and vice-versa.

### 20.1 `osmo-bts-trx` specific VTY commands

For a auto-generated complete syntax reference of the VTY commands, please see the associated *OsmoBTS VTY reference manual* [[vty-ref-osmobts](#)]. The section below only lists the most important commands.

#### 20.1.1 at the *SHOW* node

##### 20.1.1.1 `show phy <0-255> system-information`

Show information about the hardware platform, DSP and OCTPHY-2G software version.

### 20.1.1.2 `show phy <0-255> rf-port-stats <0-1>`

Show information about the RF port interfaces.

### 20.1.1.3 `show phy <0-255> clk-sync-stats`

Show information about the clock synchronization manager.

## 20.1.2 at the *PHY* configuration node

### 20.1.2.1 `octphy hw-addr HWADDR`

Specify the Ethernet hardware address (mac address) of the DSP running the OCTPHY-2G software for this PHY link.

### 20.1.2.2 `octphy net-device NAME`

Specify the Ethernet network device (like `eth0`) through which the DSP can be reached from OsmoBTS.

### 20.1.2.3 `octphy rf-port-index <0-255>`

Specify which RF port should be used for this PHY link.

### 20.1.2.4 `octphy rx-gain <0-73>`

Configure the receiver gain in dB.

### 20.1.2.5 `octphy tx-attenuation <0-359>`

Configure the transmitter attenuation in quarter-dB

## 21 `osmo-bts-virtual` for Virtual Um Interface

This is a special BTS model used for research, simulation and testing. Rather than communicating over a wireless RF interface, the GSM Um messages are encapsulated over GSMTAP/UDP/IP.

The Virtual Um interface (i.e. virtual radio layer) between OsmoBTS and OsmocomBB allows us to run a complete GSM network with 1-N BTSs and 1-M MSs without any actual radio hardware, which is of course excellent for all kinds of testing scenarios.

The Virtual Um layer is based on sending L2 frames (blocks) encapsulated via GSMTAP UDP multicast packets. There are two separate multicast groups, one for uplink and one for downlink. The multicast nature simulates the shared medium and enables any simulated phone to receive the signal from multiple BTSs via the downlink multicast group.

In OsmoBTS, this is implemented via the `osmo-bts-virtual` BTS model.

Setting up OsmoBTS in its `osmo-bts-virtual` flavor isn't really much different from setting it up with real hardware. The amount of required configuration at the BTS configuration file is (as always) very minimal, as in the GSM network architecture provides almost all relevant configuration to the BTS from the BSC.

An example configuration file is provided as part of the `osmo-bts` source code: `doc/examples/virtual/osmobts-virtual.cf`

For more information see [http://osmocom.org/projects/cellular-infrastructure/wiki/Virtual\\_Um](http://osmocom.org/projects/cellular-infrastructure/wiki/Virtual_Um)



## 21.1 osmo-bts-virtual specific VTY commands

For a auto-generated complete syntax reference of the VTY commands, please see the associated *OsmoBTS VTY reference manual* [[vty-ref-osmobts](#)]. The section below only lists the most important commands.

### 21.1.1 at the *PHY* config node

#### 21.1.1.1 `virtual-um net-device NETDEV`

Configure the network device used for sending/receiving the virtual Um interface messages (e.g. `eth0`).

#### 21.1.1.2 `virtual-um ms-udp-port <0-65535>`

Configure the UDP port used for sending virtual Um downlink messages towards the MS (default: GSMTAP 4729).

#### 21.1.1.3 `virtual-um ms-multicast-group GROUP`

Configure the IP multicast group used for sending virtual Um downlink messages towards the MS (default: 239.193.23.1)

#### 21.1.1.4 `virtual-um bts-udp-port <0-65535>`

Configure the UDP port used for receiving virtual Um uplink messages from the MS (default: GSMTAP 4729).

#### 21.1.1.5 `virtual-um bts-multicast-group GROUP`

Configure the IP multicast group used for receiving virtual Um uplink messages from the MS (default: 239.193.23.2)

## 22 OsmoBTS software architecture

### 22.1 OsmoBTS PHY interface abstraction

The OsmoBTS PHY interface serves as an internal abstraction layer between given PHY hardware (as provided by the `bts_model`) and the actual logical transceivers (TRXs) of a BTS inside the OsmoBTS code base.

#### 22.1.1 PHY link

A PHY link is a physical connection / link towards a given PHY. This might be, for example,

- a set of file descriptors to device nodes in the `/dev/` directory (`sysmobts`, `litecell15`)
- a packet socket for sending raw Ethernet frames to an OCTPHY
- a set of UDP sockets for interacting with OsmoTRX

Each PHY interface has a set of attribute/parameters and a list of 1 to n PHY instances.

PHY links are numbered 0..n globally inside OsmoBTS.

Each PHY link is configured via the VTY using its individual top-level vty node. Given the different `bts-model` / `phy` specific properties, the VTY configuration options (if any) of the PHY instance differ between BTS models.

The PHY links and instances must be configured above the BTS/TRX nodes in the configuration file. If the file is saved via the VTY, the code automatically ensures this.

### 22.1.2 PHY instance

A PHY instance is an instance of a PHY, accessed via a PHY link.

In the case of osmo-bts-sysmo and osmo-bts-trx, there is only one instance in every PHY link. This is due to the fact that the API inside that PHY link does not permit for distinguishing multiple different logical TRXs.

Other PHY implementations like the OCTPHY however do support addressing multiple PHY instances via a single PHY link.

PHY instances are numbered 0..n inside each PHY link.

Each PHY instance is configured via the VTY as a separate node beneath each PHY link. Given the different bts-model / phy specific properties, the VTY configuration options (if any) of the PHY instance differ between BTS models.

### 22.1.3 Mapping PHY instances to TRXs

Each TRX node in the VTY must use the *phy N instance M* command in order to specify which PHY instance is allocated to this specific TRX.

## 22.2 Internal control flow

### 22.2.1 start-up / sequencing during OsmoBTS start

Table 7: Control flow at OsmoBTS start-up procedure

section	function	description
bts-specific	main()	Entering main() from glibc
common	bts_main()	initialization of talloc contexts
common	bts_log_init()	initialization of logging
common	handle_options()	common option parsing
bts-specific	bts_model_handle_options()	model-specific option parsing
common	gsm_bts_alloc()	allocation of BTS/TRX/TS data structures
common	vty_init()	Initialziation of VTY core, libosmo-abis and osmo-bts VTY
common	main()	Setting of scheduler RR priority (if configured)
common	main()	Initialization of GSMTAP (if configured)
common	bts_init()	configuration of defaults in bts/trx/s object
bts-specific	bts_model_init	?
common	abis_init()	Initialization of libosmo-abis
common	vty_read_config_file()	Reading of configuration file
bts-specific	bts_model_phy_link_set_defaults()	Called for every PHY link created
bts-specific	bts_model_phy_instance_set_defaults()	Called for every PHY Instance created
common	bts_controlif_setup()	Initialization of Control Interface
bts-specific	bts_model_ctrl_cmds_install()	Install model-specific control interface commands
common	telnet_init_default()	Initialization of telnet interface
common	pcu_sock_init()	Initialization of PCU socket
common	main()	Installation of signal handlers
common	abis_open()	Start of the A-bis connection to BSC
common	phy_links_open()	Iterate over list of configured PHY links
bts-specific	bts_model_phy_link_open()	Open each of the configured PHY links
bts-specific	bts_model_phy_link_close()	Close each of the configured PHY links
common	osmo_daemonize()	Fork as daemon in background (if configured)
common	bts_main()	Run main loop until global variable quit >= 2

### 22.2.2 At time of OML establishment

Table 8: Control flow at time of OML establishment

section	function	description
bts-specific	bts_model_oml_estab()	Called by core once OML link is established
bts-specific	bts_model_check_oml()	called each time OML sets some attributes on a MO, checks if attributes are valid
bts-specific	bts_model_apply_oml()	called each time OML sets some attributes on a MO, stores attribute contents in data structures
bts-specific	bts_model_opstart()	for NM_OC_BTS, NM_OC_SITE_MANAGER, NM_OC_GPRS_NSE, NM_OC_GPRS_CELL, NMO_OC_GPRS_NSVC
bts-specific	bts_model_opstart()	for NM_OC_RADIO_CARRIER for each trx
bts-specific	bts_model_opstart()	for NM_OC_BASEB_TRANSC for each trx
bts-specific	bts_model_opstart()	for NM_OC_CHANNEL for each timeslot on each trx
bts-specific	bts_model_change_power()	change transmit power for each trx (power ramp-up/ramp-down)

### 22.2.3 At time of RSL connection loss

Table 9: Control flow at time of RSL connection loss

section	function	description
bts-specific	bts_model_abis_close()	called when either one of the RSL links or the OML link are down

## 23 Osmux

Osmux is a protocol aimed at multiplexing and transmitting voice and signalling traffic from multiple sources in order to reduce the overall bandwidth consumption. This feature becomes specially meaningful in case of satellite based GSM systems, where the transmission cost on the back-haul is relatively expensive. In such environment, even seemingly small protocol optimizations, eg. message batching and trunking, can result in significant cost reduction.

Full reference document for the osmux protocol can be found here: <https://ftp.osmocom.org/docs/latest/osmux-reference.pdf>

In Osmocom satellite based GSM networks, the satellite link is envisioned to be in between the BSS and the core network, that is, between the BSC and the MSC (or BSC-NAT). Hence, Osmocom components can make use of Osmux protocol to multiplex payload audio streams from call legs between OsmoBSC and OsmoMSC (or OsmoBSCNAT). The MGW attached those components need of course also be aware of Osmux existence in order to properly set up the audio data plane.

Under some specific circumstances, the operator may decide to set up the network with a bandwidth-limited (e.g. satellite) link between BTS and BSC. Hence, use of the Osmux protocol is also possible between an Osmux capable BTS (like OsmoBTS) and OsmoBSC (and its co-located MGW).

### 23.1 Osmux and NAT

It is quite usual for satellite based links to use NATs, which means any or both of the two components at each side of the satellite link (BSC and MSC/BSC-NAT) may end up being behind a NAT and being unable to provide the real public address to its peer on the other side of the satellite.

As a result, upon call parameter negotiation (RTP/Osmux IP address and port), those parameters won't be entirely useful and some specific logic needs to be introduced into the network components to circumvent the NAT under those cases.

For instance, if the BSC and its co-located MGW (BSC/MGW from now on) is under a NAT, it may end up providing its private address and port as RTP/Osmux parameters to the MSC/MGW through GSM protocols, but MSC will fail to send any message to that tuple because of the NAT or routing issues (due to IP address being a private address). In that scenario, MSC/MGW needs to be aware that there's a NAT and wait until an RTP/Osmux message arrives from the BSC/MGW host. It then can, from that message source IP address and port (and CID in case of Osmux), discover the real public IP address and port of the peer (BSC/MGW). From that point on, the BSC/MGW punched a hole in the NAT (its connection table is updated) and MSC/MGW is able to send data back to it on that connection.

In order to make use of the features above, OsmoMGW must be made aware explicitly through VTY configuration that its peers are located behind a NAT. This is done through the `osmux peer-behind-nat (on|off)` VTY commands.

If OsmoMGW itself is behind a NAT, it must use the VTY config `rtsp keep-alive` (used for both RTP and Osmux) to at least the value `once`, in order for it to punch the hole in its NAT so that its peer can know where to send packets back to it.

Another characteristic of NATs is that they tend to drop connections from their connection tables after some inactivity time, meaning a peer may receive notice about the other end not being available while it actually is. This means the GSM network needs to be configured in a way to ensure inactivity periods are short enough that this cannot occur.

Hence, if OsmoMGW is behind a NAT, it is actually desirable to have the VTY config `rtsp keep-alive` configured with the `<1-120>` value in order to force transmission of dummy packets ever few seconds.

Osmux implementations such as OsmoMGW also come with the `osmux dummy` VTY command to enable sending dummy AMR payloads to the peer even if no real data was received (for instance if DTX is used). This is useful under some specific satellite links which were proven to work unreliably if the total throughput in use over the link changes over time. This way throughput resources are kept pre-allocated until they are needed again (audio is received again).

## 23.2 CID allocation

Each peer (BSC/MGW and MSC/MGW) allocates its own *local CID*, and receives from its peer a *remote CID* (aka the peer's *local CID*) through the used GSM protocol. This *remote CID* is then used to send Osmux frames to that peer.

```
BSC/MGW(localCID=Y,remoteCID=?)<-X--MSC/MGW(localCID=X,remoteCID=?)
BSC/MGW(localCID=Y,remoteCID=X)--Y->MSC/MGW(localCID=X,remoteCID=Y)
```

This way each peer is responsible for allocating and managing their own local address (CID) space. This is basically the same that happens with regular IP address and port in the RTP case (and those also apply when Osmux is used, but an extra identifier, the CID, is allocated).

In an ideal scenario, without NAT, each BSC/MGW would have a public, differentiated and unique IP and port set tuple, And MSC/MGW should be able to identify messages coming from them by easily matching source IP address, port (and CID in Osmux case) against the parameters negotiated during call set up.

In this kind of scenario, MSC/MGW could easily open and manage one Osmux socket per BSC (based on SDP IPAddr and port parameters), with same `<localIPAddr, localPort>` tuple, allowing for 256 Osmux CIDs per BSC and hence call legs per BSC. Each of the peers could actually have more than one Osmux socket towards the other peer, by using a pool of ports or IP addresses, so there's really not limit if required as long as there's a way to infer the initially negotiated `<srcIP, srcPort, dstIP, dstPort, remoteCID>` tuple from the received audio packets.

However, due to some constrains from in between NATs explained in section above, BSC/MGW IP address and port are not a priory known, and could change between different connections coming from it. As a result, it is difficult to infer the entire tuple, so for now MGW needs to allocate its Osmux *local CID* in a clever way, in order to be able to identify the full tuple from it.

Hence, currently OsmoMGW CID allocation implementation shares CID between all connections, which means it can only handle up to 256 concurrent Osmux connections (call legs).

Future work in OsmoMGW ([OS#4092](#)) plans to use a set of local ports for Osmux sockets instead of only 1 currently used. This way local ports can be matched against specific `<remoteIP, remotePort>` tuples and have an entire 256 Osmux CID space per `<remoteIP, remotePort>` (aka per peer).

### 23.3 3GPP AoIP network setup with Osmux

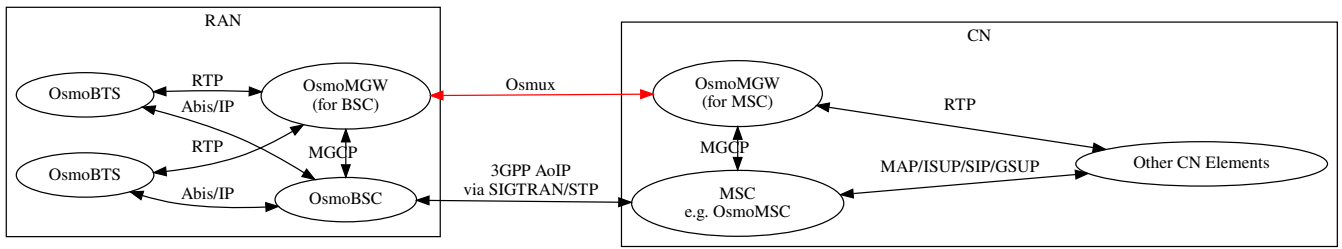

Figure 5: Sample node diagram of a 3GPP AoIP network with Osmux enabled

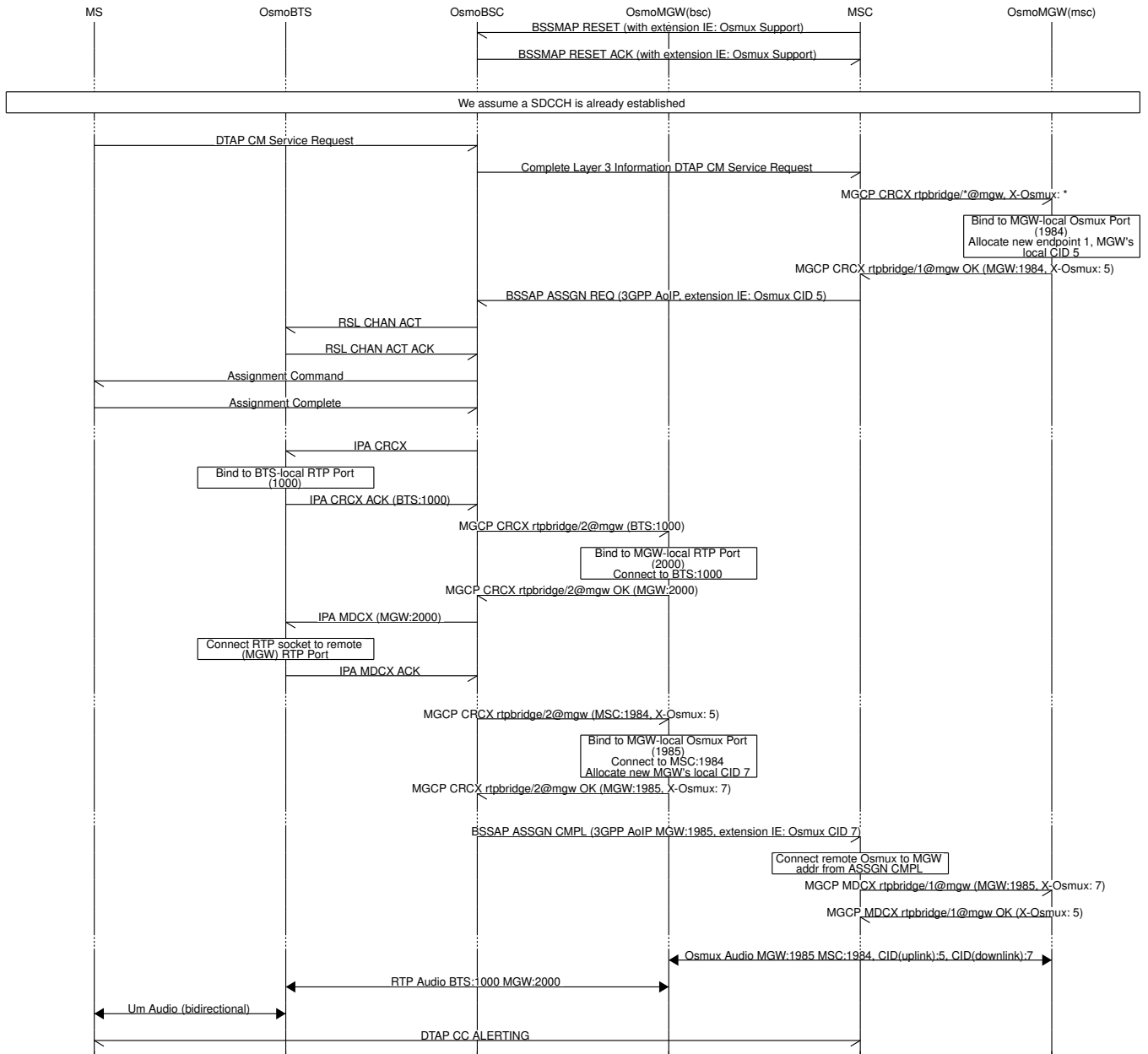

Figure 6: MO-call with Osmux enable on 3GPP AoIP

### 23.4 SCCPLite network setup with Osmux

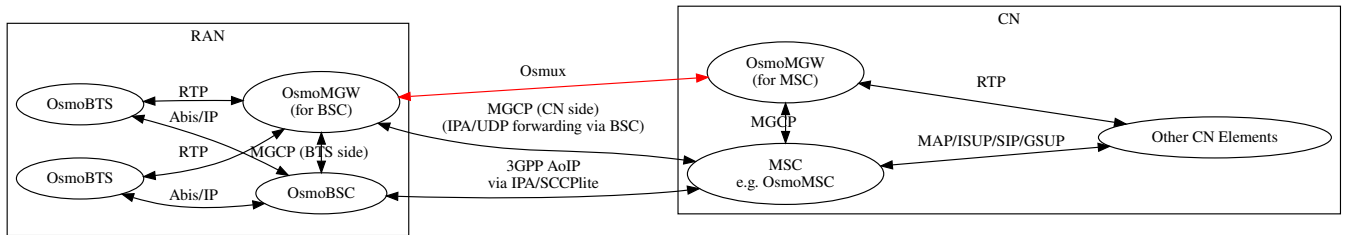

Figure 7: Sample node diagram of a 3GPP AoIP using A/IP with IPA/SCCPLite network with Osmux enabled

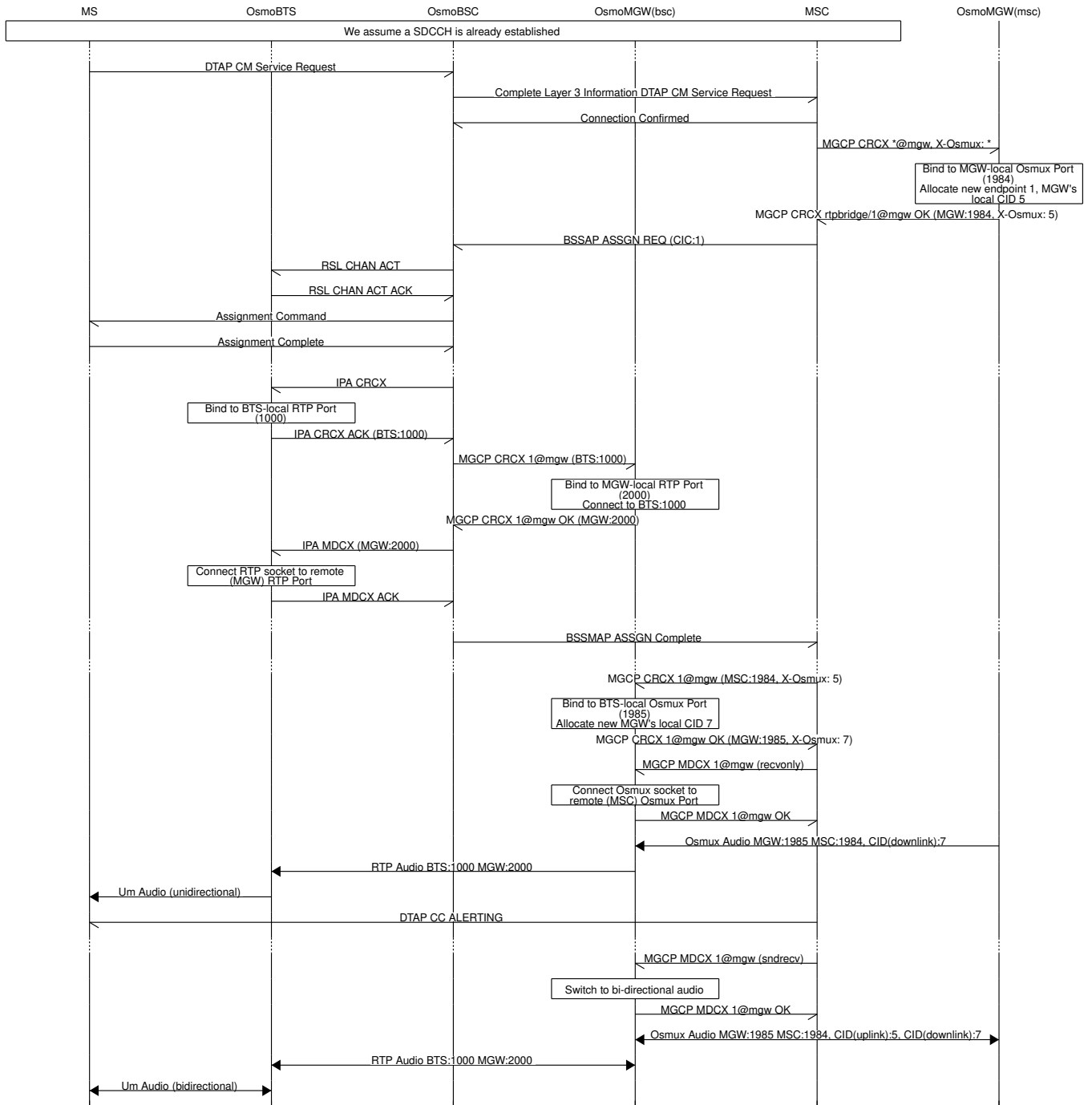

Figure 8: MO-call with Osmux enable on 3GPP AoIP using A/IP with IPA/SCCP lite



### 23.5 SCCPLite network setup with Osmux + BSC-NAT

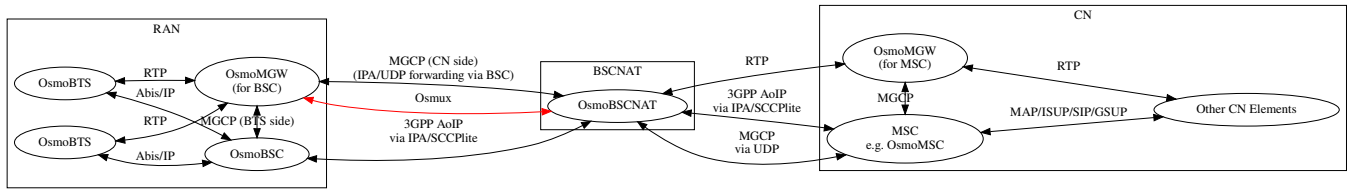

Figure 9: Sample node diagram of a 3GPP AoIP using A/IP with IPA/SCCP lite network and BSC-NAT with Osmux enabled

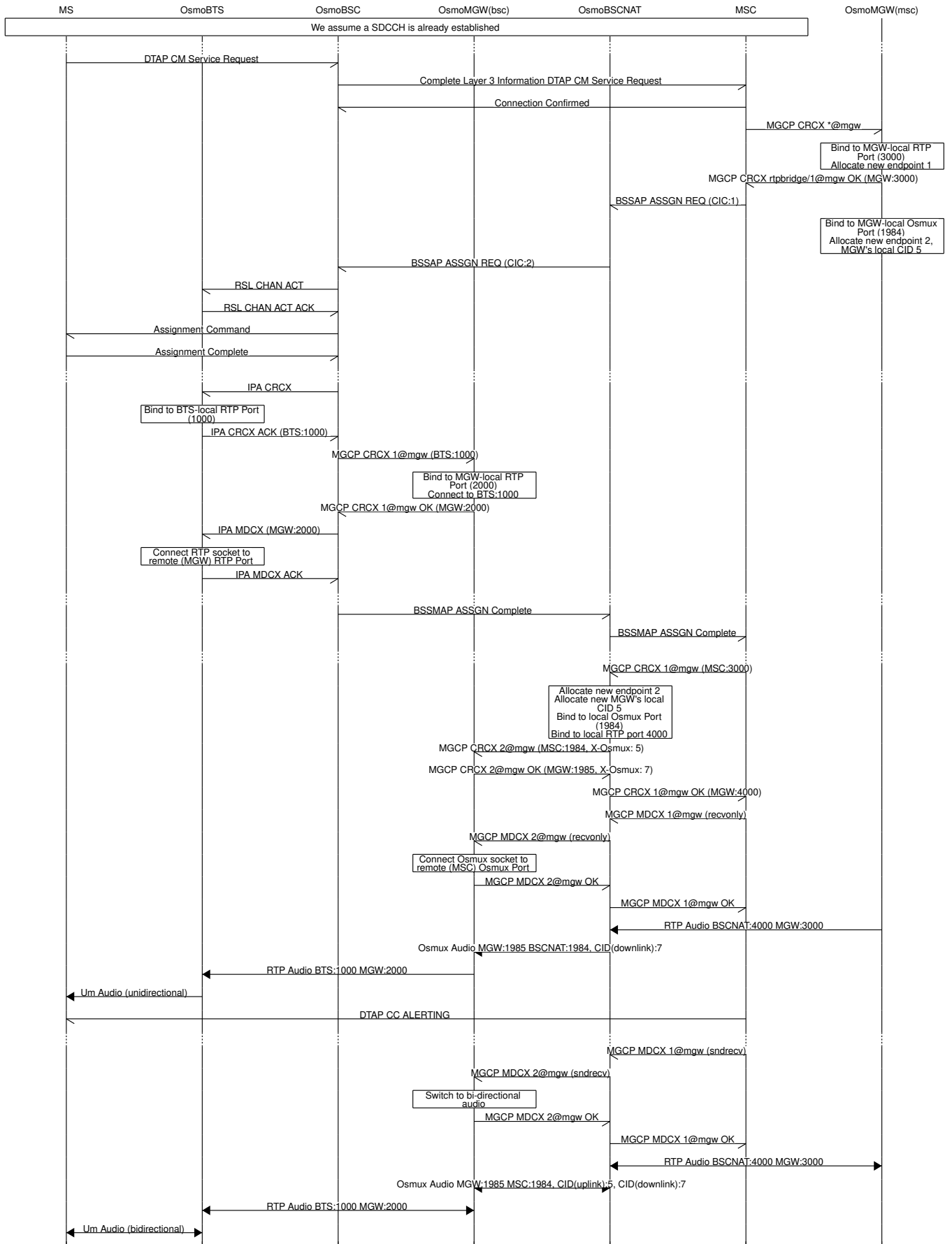

Figure 10: MO-call with Osmux enable on 3GPP AoIP using A/IP with IPA/SCCPlite with a BSC-NAT between BSC and MSC

## 23.6 Osmux and MGCP

X-Osmux indicates to OsmoMGW that a given connection of an `rtpbridge` endpoint has to be configured in order to handle Osmux frames instead of RTP messages on the data plane.

### 23.6.1 X-Osmux Format

The value part of X-Osmux must be one integer in range [0..255], or alternatively only on request messages, an asterisk (\*) if the value is not yet known.

X-Osmux must be issued in the MGCP header section (typically as its last item), before the SDP section starts.

X-Osmux can be included inside CRCX and MDCX request messages, as well as their respective response messages.

In request messages, the value part of X-Osmux specifies the CID to be used by OsmoMGW to *send* Osmux frames to the remote peer for that connection, also known as the MGW's *remote CID* or the peer's *local CID*.

In response messages, the value part of X-Osmux specifies the CID where OsmoMGW expect to *receive* Osmux frames from the remote peer for that connection, also known as the MGW's *local CID* or the peer's *remote CID*.

#### Example: X-Osmux format with a known CID 3.

```
X-Osmux: 3
```

#### Example: X-Osmux format with a wildcard (not yet known) CID.

```
X-Osmux: *
```

### 23.6.2 X-Osmux Considerations

If the MGCP client is willing to use Osmux for a given connection, it shall specify so during CRCX time, and not later. If at CRCX time the MGCP client doesn't yet know the MGW's *remote CID*, it can use an asterisk (\*) and provide *remote CID* later within MDCX messages.

All subsequent MDCX messages sent towards an Osmux connection must contain the original MGW's *remote CID* sent during CRCX. The same way, all MDCX response shall contain the *local CID* sent during CRCX.

The other required connection address parameters, such as IP address, port, and codecs, are negotiated through MGCP and SDP as usual, but in this case the IP address and port specific the Osmux socket IP address and port to use, that together with the Osmux CID conform the entire tuple identifying a Osmux stream.

Since Osmux only supports AMR codec payloads, the SDP must specify use of AMR codec.

#### Example: CRCX message that instructs OsmoMGW to create an Osmux connection

```
CRCX 189 rtpbridge/1@mgw MGCP 1.0
C: 36
M: sendrecv
X-Osmux: 2

v=0
o=- 36 23 IN IP4 172.18.2.20
s=-
c=IN IP4 1.2.3.4
t=0 0
m=audio 2342 RTP/AVP 112
a=fmtp:112
a=rtpmap:112 AMR/8000/1
a=ptime:20
```

#### Example: response to CRCX containing the MGW's local CID

```

200 189 OK
I: 07E41584
X-Osmux: 2
Z: rtpbridge/1@mgw

v=0
o=- foo 21 IN IP4 172.18.1.20
s=-
c=IN IP4 172.18.1.20
t=0 0
m=audio 11002 RTP/AVP 112
a=rtpmap:112 AMR/8000
a=ptime:20

```

### 23.6.3 X-Osmux Support

X-Osmux is known to be supported by OsmoMGW on the MGCP server side, and by OsmoBSC as well as OsmoMSC on the MGCP client side (through libosmo-mgcp-cli). No other programs supporting this feature are known or envisioned at the time of writing this document.

In OsmoMGW, Osmux support is managed through VTY.

#### Example: Sample config file section with Osmux configuration

```

mgcp
...
osmux on ❶
osmux bind-ip 172.18.1.20 ❷
osmux port 1984 ❸
osmux batch-factor 4 ❹
osmux dummy on ❺

```

- ❶ Allow clients to set allocate Osmux connections in `rtpbridge` endpoints, while still allowing RTP connections
- ❷ Bind the Osmux socket to the provided IP address
- ❸ Bind the Osmux socket to the provided UDP port
- ❹ Batch up to 4 RTP payloads of the same stream on each Osmux frame
- ❺ Periodically send Osmux dummy frames, useful to punch a hole in NATs and maintain connections opened.

### 23.7 Abis setup with Osmux

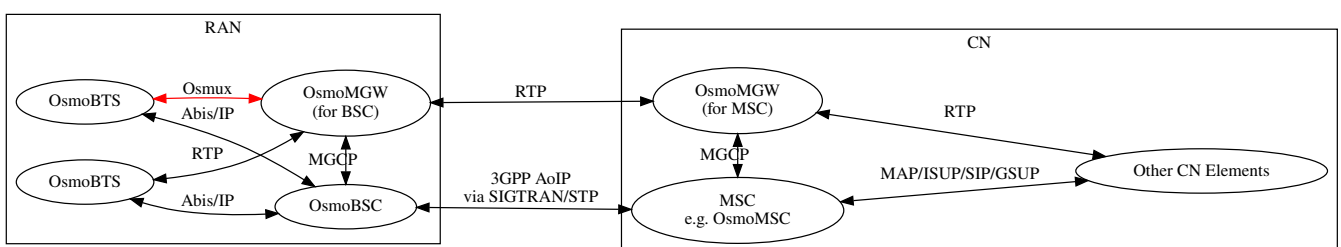

Figure 11: Sample node diagram of Osmux enabled in the Abis interface

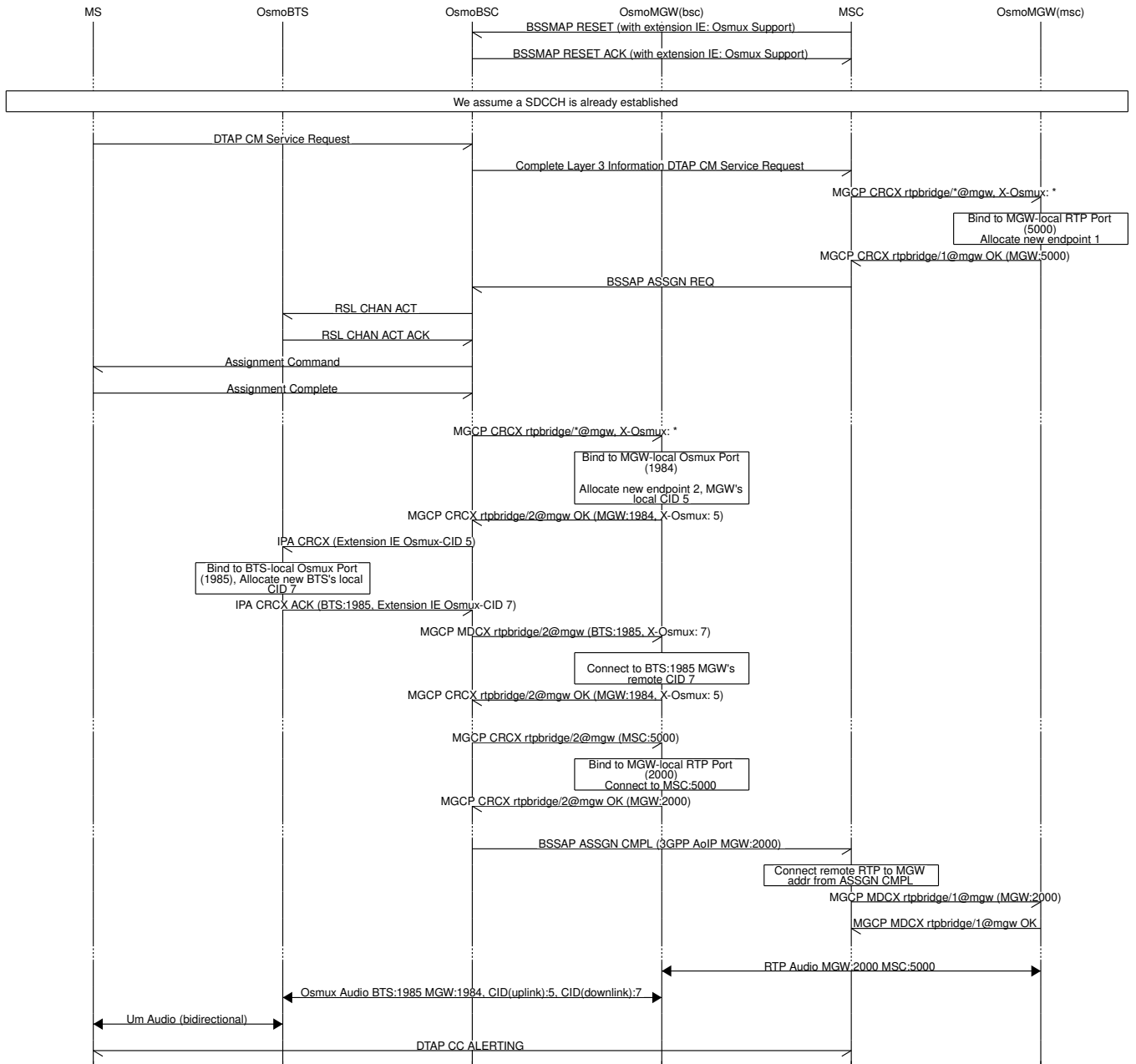

Figure 12: MO-call with Osmux enabled on Abis

### 23.8 Osmux Support in OsmoBTS

Osmux usage in OsmoBTS is managed through the VTY commands in node `osmux`. Command `use (on|off|only)` is used to configure use policy of Osmux within OsmoBTS. Once enabled (`on` or `only`), OsmoBTS will announce the *OSMUX* BTS feature towards the BSC over OML. This way, the BSC becomes aware that this BTS supports using Osmux to transfer voice call user data when the AMR codec is selected.

It is then up to the BSC to decide whether to use Osmux or not when establishing a new call. If the BSC decides to use Osmux for a given call, then the *IPACC CRCX/MDCX* messages sent by the BSC will contain an extra *Osmux CID* IE appended, which contains the Osmux CID to be used by the BTS to send Osmux frames to the co-located BSC MGW (aka the BSC MGW' local CID, or OsmoBTS' remote CID). The IP address and port provided in the same messages refer to the address and port where Osmux frames with the provided CID are expected to be received. Similarly, OsmoBTS appends an *Osmux CID* IE to the *IPACC*

*CRCX/MDCX ACK* message it generates, this time with its own local Osmux CID. Same goes for the BTS' local IP address and port where Osmux frames are expected to be received.

OsmoBTS will behave differently during call set up based on the VTY command `use (on|off|only)` presented above:

- `off`: If *IPACC CRCX* from BSC contains *Osmux CID* IE, meaning BSC wants to use Osmux for this call, then OsmoBTS will reject the request and the call set up will fail.
- `on`: OsmoBTS will support and accept both Osmux and non-Osmux (RTP) upon call set up. If *IPACC CRCX* from BSC contains the *Osmux CID* IE on a AMR call (`Channel Mode GSM3`), it will set up an Osmux stream on its end and provide the BSC with the BTS-local CID. If the BSC provides no *Osmux CID* IE, then OsmoBTS will set up a regular RTP based call.
- `only`: Same as per `on`, except that OsmoBTS will accept only Osmux calls on the CN-side, this is, if *IPACC CRCX* from BSC doesn't contain an *Osmux CID* IE, it will reject the assignment and the call set up will fail. This means also that only AMR calls (`Channel Mode GSM3`) are allowed.

## 24 QoS, DSCP/TOS, Priority and IEEE 802.1q PCP

In many use cases operators want to apply different QoS classes for user plane vs. control plane traffic. IP Routers, Ethernet switches and other network gear can then perform intelligent queue management as required for the respective service.

For example, voice user plane frames need a rather stable and short latency, while IP user plane and control plane traffic has less critical latency requirements.

### 24.1 IP Level (DSCP)

At IP level, different priorities / classes of traffic are expressed in accordance to [\[ietf-rtc2474\]](#) by the DSCP (Differentiated Services Code Point) field of the IP header. DSCP resembles the upper 6 bits of the field formerly known as the TOS bits as per [\[ietf-rtc791\]](#).

On Linux and other operating systems with BSD-style sockets API, the applications can request a specific DSCP value to be used for packets generated by those sockets.

Osmocomm CNI software such as `osmo-bts` and `osmo-mgw` support setting the DSCP value via VTY commands, see e.g. the `rtcp ip-dscp` setting of the `bts` node in `osmo-bts`.

### 24.2 Packet Priority

In the Linux network stack, every packet is represented by `struct sk_buff`, which has an associated *priority*. Furthermore, every socket through which applications send data have an associated *socket priority*. Each time a packet is transmitted through a given socket, the packet inherits the packet priority from the socket priority.

Furthermore, there is a mapping table that maps DSCP/TOS bits to priority. The sixteen different TOS bit values are mapped to priority values as follows:

Table 10: Linux kernel default DSCP/TOS → priority mapping

TOS (binary)	DSCP (binary)	Priority (decimal)
xxx0000x	xxx000	0
xxx0001x	xxx000	0
xxx0010x	xxx001	0
xxx0011x	xxx001	0
xxx0100x	xxx010	2
xxx0101x	xxx010	2
xxx0110x	xxx011	2

Table 10: (continued)

TOS (binary)	DSCP (binary)	Priority (decimal)
xxx0111x	xxx011	2
xxx1000x	xxx100	6
xxx1001x	xxx100	6
xxx1010x	xxx101	6
xxx1011x	xxx101	6
xxx1100x	xxx110	4
xxx1101x	xxx110	4
xxx1110x	xxx111	4
xxx1111x	xxx111	4

This table of default DSCP/TOS → priority bit mappings cannot be modified.

However, the per-packet *priority* values can be set by various means of network policy, including

- by packet filter rules (iptables, ip6tables, nftables)
  - if you use iptables, using `CLASSIFY --set-class` in the mangle table
  - if you use nftables, using `meta priority set` in the mangle table
- by the application using the `SO_PRIORITY` socket option (currently not yet supported by Osmocom CNI)

### 24.3 Ethernet Level (PCP)

At Ethernet level, different priorities / QoS classes are expressed by the so-called PCP (Priority Code Point) field in the IEEE 802.1q (VLAN) header.

#### NOTE

This means that PCP functionality requires the use of IEEE 802.q VLAN. You cannot use PCP without VLAN.

The Linux kernel assigns IEEE 802.1q PCP bits based on a *mapping* between the *priority* and the PCP value. Each VLAN network device maintains a separate map for both egress (transmit) and ingress (receive) path.

The current priority mappings can be inspected via the `/proc` filesystem. For example, if you have a VLAN device `eth0.9` for VLAN ID 9 on the net-device `eth0`, you can use the following example:

#### Example: Inspecting the current egress QoS map

```
$ sudo cat /proc/net/vlan/eth0.9❶
eth0.9  VID: 9  REORDER_HDR: 1  dev->priv_flags: 1021
        total frames received      123340
        total bytes received      40668066
        Broadcast/Multicast Rcvd   1106

        total frames transmitted    10499
        total bytes transmitted    1570809
Device: eth0
INGRESS priority mappings: 0:0  1:0  2:0  3:0  4:0  5:0  6:0  7:0 ❷
EGRESS priority mappings: ❸
```

- ❶ make sure to specify your specific VLAN interface name here instead of `eth0.9`

- ❷ ingress priority mappings (all PCP values mapped to priority 0)
- ❸ egress priority mappings (empty)

As we can see in the above example, there are no egress priority mappings yet. Let's create three new mappings, mapping *priority* value 1 to PCP 1, *priority* 2 to PCP 2, and *priority* 3 to PCP 3:

#### Example: Creating three new egress QoS mappings

```
$ sudo ip link set dev eth0.9❶ type vlan egress-qos-map 1:1 2:2 3:3❷
$ sudo cat /proc/net/vlan/eth0.9❸
eth0.9  VID: 9  REORDER_HDR: 1  dev->priv_flags: 1021
        total frames received      123898
        total bytes received       40843611
        Broadcast/Multicast Rcvd   1106

        total frames transmitted    10517
        total bytes transmitted     1574357
Device: eth0
INGRESS priority mappings: 0:0  1:0  2:0  3:0  4:0  5:0  6:0  7:0
EGRESS priority mappings: 1:1  2:2  3:3❹
```

- ❶ make sure to specify your specific VLAN interface name here instead of `eth0.9`
- ❷ command to define three new egress QoS maps
- ❸ command to re-display the current status
- ❹ three new egress mappings are shown as given in `ip` command

#### NOTE

The settings of the `ip` command are volatile and only active until the next reboot (or the network device or VLAN is removed). Please refer to the documentation of your specific Linux distribution in order to find out how to make such settings persistent by means of an `ifup` hook whenever the interface comes up. For CentOS/RHEL 8 this can e.g. be achieved by means of an `/sbin/ifup-local` script (when using `network-scripts` and not `NetworkManager`). For Debian or Ubuntu, this typically involves adding up lines to `/etc/network/interfaces` or a `/etc/network/if-up.d` script.

## 24.4 Putting things together

Assuming one needs to set both the DSCP bits as well as the PCP for certain traffic, the above-mentioned mechanisms need to be combined as follows:

1. configure the `osmocom` program to set the DSCP value
2. use the default DSCP → priority mapping, if possible
3. configure an egress QoS map to map from priority to PCP

If the desired combination of DSCP + PCP cannot be achieved that way, due to the rather static default kernel mapping table, one needs to go one step further:

1. configure the `osmocom` program to set the DSCP value
2. use packet filter rules to set the priority based on DSCP
3. configure an egress QoS map to map from priority to PCP



### 24.4.1 Full example of QoS for osmo-bts uplink QoS

In the below example we will show the full set of configuration required for both DSCP and PCP differentiation of uplink Abis traffic by osmo-bts.

What we want to achieve in this example is the following configuration:

Table 11: DSCP and PCP assignments for osmo-bts uplink traffic in this example

Traffic	DSCP	PCP
A-bis RSL	56	7
A-bis RTP	46	6
A-bis OML	34	5

1. configure the osmocom program to set the DSCP value
2. configure an egress QoS map to map from priority to PCP

#### Example Step 1: add related VTY configuration to osmo-bts.cfg

```
...
el_input
 ipa ip-dscp oml 34
 ipa socket-priority oml 5
 ipa ip-dscp rsl 56
 ipa socket-priority rsl 7
...
bts 0
 rtp ip-dscp 46
 rtp socket-priority 6
...
```

#### Example Step 2: egress QoS map to map from socket priority to PCP values

```
$ sudo ip link set dev eth0.9❶ type vlan egress-qos-map 0:0 1:1 5:5 6:6 7:7❷
```

- ❶ make sure to specify your specific VLAN interface name here instead of `eth0.9`.
- ❷ create a egress QoS map that maps the priority value 1:1 to the PCP. We also include the mapping 1:1 from the osmo-pcu example (see [userman-osmopcu](#)) here.

#### NOTE

The settings of the `ip` command are volatile and only active until the next reboot (or the network device or VLAN is removed). Please refer to the documentation of your specific Linux distribution in order to find out how to make such settings persistent by means of an `ifup` hook whenever the interface comes up. For CentOS/RHEL 8 this can e.g. be achieved by means of an `/sbin/ifup-local` script (when using `network-scripts` and not `NetworkManager`). For Debian or Ubuntu, this typically involves adding up lines to `/etc/network/interfaces` or a `/etc/network/if-up.d` script.

## 25 VTY Process and Thread management

Most Osmocom programs provide, some support to tune some system settings related to the running process, its threads, its scheduling policies, etc.

All of these settings can be configured through the VTY, either during startup by means of usual config files or through direct human interaction at the telnet VTY interface while the process is running.

## 25.1 Scheduling Policy

The scheduler to use as well as some of its properties (such as realtime priority) can be configured at any time for the entire process. This sort of functionality is useful in order to increase priority for processes running time-constrained procedures, such as those acting on the Um interface, like *osmo-trx* or *osmo-bts*, where use of this feature is highly recommended.

### Example: Set process to use RR scheduler

```
cpu-sched
policy rr 1 ❶
```

- ❶ Configure process to use *SCHED\_RR* policy with real time priority 1

## 25.2 CPU-Affinity Mask

Most operating systems allow for some sort of configuration on restricting the amount of CPUs a given process or thread can run on. The procedure is sometimes called as *cpu-pinning* since it allows to keep different processes pinned on a subset of CPUs to make sure the scheduler won't run two CPU-hungry processes on the same CPU.

The set of CPUs where each thread is allowed to run on is expressed by means of a bitmask in hexadecimal representation, where the right most bit relates to CPU 0, and the Nth most significant bit relates to CPU *N-1*. Setting the bit means the process is allowed to run on that CPU, while clearing it means the process is forbidden to run on that CPU.

Hence, for instance a *cpu-affinity* mask of *0x00* means the thread is not allowed on any CPU, which will cause the thread to stall until a new value is applied. A mask of *0x01* means the thread is only allowed to run on the 1st CPU (CPU 0). A mask of *0xff00* means CPUs 8-15 are allowed, while 0-7 are not.

For single-threaded processes (most of Osmocom are), it is usually enough to set this line in VTY config file as follows:

```
cpu-sched
cpu-affinity self 0x01 ❶
```

- ❶ Allow main thread (the one managing the VTY) only on CPU 0

Or otherwise:

```
cpu-sched
cpu-affinity all 0x01 ❶
```

- ❶ Allow all threads only on CPU 0

For multi-threaded processes, it may be desired to run some threads on a subset of CPUs while another subset may run on another one. In order to identify threads, one can either use the TID of the thread (each thread has its own PID in Linux), or its specific Thread Name in case it has been set by the application.

The related information on all threads available in the process can be listed through VTY. This allows identifying quickly the different threads, its current *cpu-affinity* mask, etc.

### Example: Get osmo-trx Thread list information from VTY

```
OsmoTRX> show cpu-sched threads
Thread list for PID 338609:
TID: 338609, NAME: 'osmo-trx-uhd', cpu-affinity: 0x3
TID: 338610, NAME: 'osmo-trx-uhd', cpu-affinity: 0x3
TID: 338611, NAME: 'osmo-trx-uhd', cpu-affinity: 0x3
TID: 338629, NAME: 'osmo-trx-uhd', cpu-affinity: 0x3
TID: 338630, NAME: 'osmo-trx-uhd', cpu-affinity: 0x3
TID: 338631, NAME: 'osmo-trx-uhd', cpu-affinity: 0x3
TID: 338634, NAME: 'UHDAsyncEvent', cpu-affinity: 0x3
```

```
TID: 338635, NAME: 'TxLower', cpu-affinity: 0x3
TID: 338636, NAME: 'RxLower', cpu-affinity: 0x3
TID: 338637, NAME: 'RxUpper0', cpu-affinity: 0x3
TID: 338638, NAME: 'TxUpper0', cpu-affinity: 0x3
TID: 338639, NAME: 'RxUpper1', cpu-affinity: 0x3
TID: 338640, NAME: 'TxUpper1', cpu-affinity: 0x3
```

At runtime, one can change the cpu-affinity mask for a given thread identifying it by either TID or name:

#### Example: Set CPU-affinity from VTY telnet interface

```
OsmoTRX> cpu-affinity TxLower 0x02 ❶
OsmoTRX> cpu-affinity TxLower 0x03 ❷
```

- ❶ Allow thread named *TxLower* (338635) only on CPU 1
- ❷ Allow with TID 338636 (*RxLower*) only on CPU 0 and 1

Since thread names are set dynamically by the process during startup or at a later point after creating the thread itself, One may need to specify in the config file that the mask must be applied by the thread itself once being configured rather than trying to apply it immediately. To specify so, the *delay* keyword is using when configuring in the VTY. If the *delay* keyword is not used, the VTY will report an error and fail at startup when trying to apply a cpu-affinity mask for a yet-to-be-created thread.

#### Example: Set CPU-affinity from VTY config file

```
cpu-sched
cpu-affinity TxLower 0x01 delay ❶
```

- ❶ Allow thread named *TxLower* (338635) only on CPU 1. It will be applied by the thread itself when created.

## 26 TRX Manager UDP socket interface

This is the protocol used between `osmo-trx` (the transceiver) and `osmo-bts-trx` (the BTS or core).

Each TRX Manager UDP socket interface represents a single transceiver (ARFCN). Each of these channels is a pair of UDP sockets, one for control (TRXC) and one for data (TRXD). Additionally, there's a separate global socket managing the Master Clock Interface, shared among all channels.

Given a base port  $B$  (5700), and a set of channels  $0 \dots N$ , the ports related to a channel  $0 \leq X \leq N$  are:

- The Master clock interface is located on port  $P=B$ .
- The TRXC interface for channel  $X$  is located on port  $P=B+2X+1$
- The TRXD interface for channel  $X$  is located on port  $P=B+2X+2$ .

The corresponding interface for every socket is at  $P+100$  on the BTS side.

---

#### Note

Starting from TRXDv2, it's possible to use only one socket for all channels. In this case, the global TRXD interface for all channels shall be established on port  $P=B+1$ . See Section [26.3.4](#) for more details.

---

## 26.1 Indications on the Master Clock Interface

The master clock interface is output only (uplink, from the radio to the BTS). Messages are "indications".

CLOCK gives the current value of the transceiver clock to be used by the BTS. This message is usually sent around once per second (217 GSM frames), but can be sent at any time. The clock value is NOT the current transceiver time. It is a time setting that the BTS should use to give better packet arrival times. The initial clock value is taken randomly, and then increased over time as the transceiver submits downlink packets to the radio.

```
IND CLOCK <totalFrames>
```

## 26.2 TRXC protocol

The per-ARFCN control interface uses a command-response protocol. Each command has a corresponding response. Commands are sent in downlink direction (BTS → TRX), and responses are sent in uplink direction (TRX → BTS). Commands and responses are NULL-terminated ASCII strings.

Every command is structured this way:

```
CMD <cmdtype> [params]
```

The <cmdtype> is the actual command. Parameters are optional depending on the commands type.

Every response is of the form:

```
RSP <cmdtype> <status> [result]
```

The <status> is 0 for success and a non-zero error code for failure. Successful responses may include results, depending on the command type.

### 26.2.1 Power Control

POWEROFF shuts off transmitter power and stops the demodulator.

```
CMD POWEROFF
RSP POWEROFF <status>
```

POWERON starts the transmitter and starts the demodulator. Initial power level is by default very low, unless set explicitly by SETPOWER/ADJPOWER beforehand while in POWEROFF state. This command fails if the transmitter and receiver are not yet tuned. This command fails if the transmit or receive frequency creates a conflict with another ARFCN that is already running. If the transceiver is already on, it answers successfully to this command.

```
CMD POWERON
RSP POWERON <status>
```

NOMTXPOWER is used by the BTS to retrieve the nominal output transmit power of the transceiver. SETPOWER/ADJPOWER attenuations (dB) are expected to be applied based on this value (dBm).

```
CMD NOMTXPOWER
RSP NOMTXPOWER <status> <dBm>
```

SETPOWER sets transmit power attenuation wrt the nominal transmit power of the transceiver, in dB.

```
CMD SETPOWER <dB>
RSP SETPOWER <status> <dB>
```

ADJPOWER adjusts by the given dB the transmit power attenuation of the transceiver. Response returns resulting transmit power attenuation wrt the nominal transmit power of the transceiver.

```
CMD ADJPOWER <dBStep>
RSP ADJPOWER <status> <dBLevel>
```

RFMUTE locks the RF transceiver, hence disabling emission and reception of information on Air interface of the channel associated to the TRXC connection the command is sent on. Parameter with value of 1 is used to mute, and value of 0 is used to unmute.

```
CMD RFMUTE <1|0>
RSP RFMUTE <status> <1|0>
```

### 26.2.2 Tuning Control

RXTUNE tunes the receiver to a given frequency in kHz. This command fails if the receiver is already running. (To re-tune you stop the radio, re-tune, and restart.) This command fails if the transmit or receive frequency creates a conflict with another ARFCN that is already running.

```
CMD RXTUNE <kHz>
RSP RXTUNE <status> <kHz>
```

TXTUNE tunes the transmitter to a given frequency in kHz. This command fails if the transmitter is already running. (To re-tune you stop the radio, re-tune, and restart.) This command fails if the transmit or receive frequency creates a conflict with another ARFCN that is already running.

```
CMD TXTUNE <kHz>
RSP TXTUNE <status> <kHz>
```

### 26.2.3 Training Sequence configuration

The usual way to configure all timeslots at once involves sending of the SETTSC command with a desired Training Sequence Code <tsc>:

```
CMD SETTSC <tsc>
RSP SETTSC <status> <tsc>
```

This command instructs the transceiver to use the given Training Sequence Code from the TSC set 1 (see 3GPP TS 45.002, table 5.2.3a) for Normal Burst detection on the receive path. It does not affect the transmit path because bursts coming from the BTS do contain the Training Sequence bits.

### 26.2.4 Timeslot Control

SETSLOT sets the format of a given uplink timeslot in the ARFCN. The <timeslot> indicates the timeslot of interest. The <chantype> indicates the type of channel that occupies the timeslot. A chantype of zero indicates the timeslot is off.

```
CMD SETSLOT <timeslot> <chantype>
RSP SETSLOT <status> <timeslot> <chantype>
```

Here's the list of channel combinations and related values (<chantype>):

Table 12: List of channel combinations and related values (<chantype>)

value	Channel Combination
0	Channel is transmitted, but unused
1	TCH/FS

Table 12: (continued)

value	Channel Combination
2	TCH/HS, idle every other slot
3	TCH/HS
4	Downlink: FCCH + SCH + CCCH + BCCH, Uplink: RACH
5	Downlink: FCCH + SCH + CCCH + BCCH + SDCCH/4 + SACCH/4, Uplink: RACH+SDCCH/4
6	Downlink: CCCH+BCCH, Uplink: RACH
7	SDCCH/8 + SACCH/8
8	TCH/F + FACCH/F + SACCH/M
9	TCH/F + SACCH/M
10	TCH/FD + SACCH/MD
11	PBCCH+PCCCH+PDTCH+PACCH+PTCCH
12	PCCCH+PDTCH+PACCH+PTCCH
13	PDTCH+PACCH+PTCCH

#### 26.2.4.1 Multiple Training Sequences (optional)

For some setups it's insufficient to have a single Training Sequence Code assigned to all timeslots of a transceiver. It may be required to use different TSCs for some (or even all) timeslots. This can be achieved by sending SETSLOT command with additional arguments:

```
CMD SETSLOT <timeslot> <chantype> [ C<c>/S<s> ]
RSP SETSLOT <status> <timeslot> <chantype> [ C<c>/S<s> ]
```

where <c> is a Training Sequence Code from TSC set <s>.

#### Note

The numbering of both Training Sequence Code and set shall be the same as in 3GPP TS 45.002, e.g. C0S1 corresponds to the first sequence in the first TSC set for a chosen modulation type. TSC Set number 0 (S0) does not exist in the specs.

#### Example: configuring timeslot 4 to use TCH/F and TSC 7 from set 1

```
CMD SETSLOT 4 1 C7/S1
RSP SETSLOT 0 4 1 C7/S1
```

Unless explicitly configured as described above, all timeslots will be using the default Training Sequence Code and set configured with the SETTSC command.

#### 26.2.4.2 VAMOS enabled channel combinations (optional)

The BTS may at any time re-configure channel combination of a timeslot (primarily during channel activation) to activate or deactivate VAMOS mode in the transceiver. For this purpose, the following additional channel combinations shall be used:

Table 13: List of VAMOS enabled channel combinations and related values

value	Channel Combination
VFF	V0(TCH/F) & V1(TCH/F), 2 channels total

Table 13: (continued)

value	Channel Combination
VHH	V0(TCH/H0) & V1(TCH/H0) + V0(TCH/H1) & V1(TCH/H1), 4 channels total
VFH	V0(TCH/F) & V1(TCH/H0) + V0(TCH/F) & V1(TCH/H1), 3 channels total
HVHH	TCH/H0 + V0(TCH/H1) & V1(TCH/H1), 3 channels total (mixed)

where both V0 and V1 define a *VAMOS pair*. Symbols & and + indicate simultaneous and sequential transmission in the TDMA domain respectively. Therefore a combination V0 (a) & V1 (b) indicates that both channels a and b are simultaneously active during a timeslot period.

#### Example: VFF in time domain (2 channels)

```
MS1: | V0 (TCH/F) | V0 (TCH/F) | V0 (TCH/F) | V0 (TCH/F) | ...
-----+-----+-----+-----+-----+-----> TDMA frames
MS2: | V1 (TCH/F) | V1 (TCH/F) | V1 (TCH/F) | V1 (TCH/F) | ...
```

#### Example: VHH in time domain (4 channels)

```
MS1: | V0 (TCH/H0) |           | V0 (TCH/H0) |           | ...
MS2: |           | V0 (TCH/H1) |           | V0 (TCH/H1) | ...
-----+-----+-----+-----+-----> TDMA frames
MS3: | V1 (TCH/H0) |           | V1 (TCH/H0) |           | ...
MS4: |           | V1 (TCH/H1) |           | V1 (TCH/H1) | ...
```

#### Example: VFH in time domain (3 channels)

```
MS1: | V0 (TCH/F) | V0 (TCH/F) | V0 (TCH/F) | V0 (TCH/F) | ...
-----+-----+-----+-----+-----> TDMA frames
MS2: | V1 (TCH/H0) |           | V1 (TCH/H0) |           | ...
MS3: |           | V1 (TCH/H1) |           | V1 (TCH/H1) | ...
```

#### Example: HVHH in time domain (3 channels)

```
MS1: | TCH/H0 |           | TCH/H0 |           | ...
MS2: |           | V0 (TCH/H1) |           | V0 (TCH/H1) | ...
-----+-----+-----+-----> TDMA frames
MS3: |           | V1 (TCH/H1) |           | V1 (TCH/H1) | ...
```

#### Note

Combination HVHH is special, because it allows the network to multiplex a legacy user device (MS1) with a pair of VAMOS capable devices (MS2 and MS3) on the same timeslot, so the former (MS1) is neither required to support the new orthogonal TSC sets nor conform to DARP phase I or II (SAIC support).

For all VAMOS enabled channel combinations, it's **required** to specify Training Sequence Code and the TSC set values for all multiplexed subscribers. See 3GPP TS 45.002, table 5.2.3e for more details on TSC set selection.

#### Example: configuring a timeslot to use VFF combination

```
CMD SETSLOT <timeslot> VFF C0/S1 ① C0/S2 ②
RSP SETSLOT <status> <timeslot> VFF C0/S1 C0/S2
```

- ❶ V0(TCH/F) is configured to use TSC 0 from set 1 (table 5.2.3a).
- ❷ V1(TCH/F) is configured to use TSC 0 from set 2 (table 5.2.3b).

#### Example: configuring a timeslot to use VFF combination (legacy MS)

```
CMD SETSLOT <timeslot> VFF C7/S1 ❶ C4/S1 ❷
RSP SETSLOT <status> <timeslot> VFF C7/S1 C4/S1
```

- ❶ V0(TCH/F) is configured to use TSC 7 from set 1 (table 5.2.3a).
- ❷ V1(TCH/F) is configured to use TSC 4 from set 1 (table 5.2.3a).

#### Note

Using Training Sequences from the same set for a *VAMOS pair* (in this example, C7/S1 C4/S1) is not recommended because of their bad cross-correlation properties. The only exception is when two legacy non-VAMOS capable phones are paired together and neither of them does support additional TSC sets.

#### Example: configuring a timeslot to use VHH combination

```
CMD SETSLOT <timeslot> VHH C1/S3 ❶ C1/S4 ❷
RSP SETSLOT <status> <timeslot> VHH C1/S3 C1/S4
```

- ❶ V0(TCH/H0) and V0(TCH/H1) are configured to use TSC 1 from set 3 (table 5.2.3c).
- ❷ V1(TCH/H0) and V1(TCH/H1) are configured to use TSC 1 from set 4 (table 5.2.3d).

#### Example: configuring a timeslot to use VFH combination

```
CMD SETSLOT <timeslot> VFH C2/S1 ❶ C2/S4 ❷
RSP SETSLOT <status> <timeslot> VFH C2/S1 C2/S4
```

- ❶ V0(TCH/F) is configured to use TSC 2 from set 1 (table 5.2.3a).
- ❷ V1(TCH/H0) and V1(TCH/H1) are configured to use TSC 2 from set 4 (table 5.2.3d).

#### Example: configuring a timeslot to use HVHH combination

```
CMD SETSLOT <timeslot> HVHH C0/S1 ❶ C0/S1 ❷ C0/S2 ❸
RSP SETSLOT <status> <timeslot> HVHH C0/S1 C0/S1 C0/S2
```

- ❶ Legacy TCH/H0 is configured to use TSC 0 from set 1 (table 5.2.3a).
- ❷ V0(TCH/H1) is configured to use TSC 0 from set 1 (table 5.2.3a).
- ❸ V1(TCH/H1) is configured to use TSC 0 from set 2 (table 5.2.3b).

#### Note

In the example for HVHH, legacy TCH/H0 does not belong to a *VAMOS pair*, so it can be configured to use any Training Sequence Code without restrictions.



### 26.2.5 TRXD header version negotiation

Messages on DATA interface may have different formats, defined by a version number, which can be negotiated on the control interface. By default, the Transceiver will use the legacy header version (0). See Section 26.3.1.

The format negotiation can be initiated by the BTS using SETFORMAT command. If the requested version is not supported by the transceiver, status code of the response message should indicate a preferred (basically, the latest) version. The format of this message is the following:

```
CMD SETFORMAT <ver_req>
RSP SETFORMAT <ver_rsp> <ver_req>
```

where:

- <ver\_req> is the requested version (suggested by the BTS),
- <ver\_rsp> is either the applied version if matches <ver\_req>, or a preferred version if <ver\_req> is not supported.

If the transceiver indicates <ver\_rsp> different than <ver\_req>, the BTS is supposed to re-initiate the version negotiation using the suggested <ver\_rsp>. For example:

```
BTS -> TRX: CMD SETFORMAT 2
BTS <- TRX: RSP SETFORMAT 1 2

BTS -> TRX: CMD SETFORMAT 1
BTS <- TRX: RSP SETFORMAT 1 1
```

If no suitable <ver\_rsp> is found, or the <ver\_req> is incorrect, the status code in the response shall be -1.

As soon as <ver\_rsp> matches <ver\_req> in the response, the process of negotiation is complete. Changing the header version is supposed to be done before POWERON, but can be also done afterwards.

## 26.3 TRXD protocol

Messages on the data interface carry one or optionally multiple radio bursts (see Section 26.3.4) per one UDP datagram. Two kinds of TRXD PDU exist:

- TRX -> L1 (from transceiver to the L1): Uplink messages received from the MS,
- L1 -> TRX (from the L1 to transceiver): Downlink messages sent to the MS.

Depending on the origin and the version indicator, PDUs may have different structure.

### 26.3.1 PDU versioning

The format of a PDU, i.e. presence and ordering of certain fields, is determined by the version number indicated in the first octet. This is usually referred as TRXDvN, where N is the version number (e.g. TRXDv0 or TRXDv1). A version number indicates the message format to be used for both directions: TRX -> L1 and L1 -> TRX. The same version shall be used for all messages in both directions, mixing in any way is not permitted.

The version negotiation is optionally initiated by the L1 on the control interface, and expected to be performed before starting the transceiver (i.e. sending POWERON command). See Section 26.2.5.

The current header allows to distinguish up to 16 different versions. The following versions are defined so far:

- TRXDv0 - initial version of TRXD protocol, inherited as-is from OpenBTS project.
- TRXDv1 (proposed in July 2019):

- Introduced the concept of protocol versioning;
  - Introduced NOPE / IDLE indications;
  - New field: MTS (Modulation and Training Sequence);
  - New field: C/I (Carrier-to-interface) ratio;
  - Downlink messages mostly unchanged.
- TRXDv2 (proposed in January 2021):
    - Introduced the concept of burst batching (many bursts in one message);
    - Changed the field ordering (facilitating aligned access);
    - New field: batching indicator;
    - New field: shadow indicator;
    - New field: TRX number;
    - New field: SCPIR for VAMOS.

### 26.3.2 Uplink PDU format

An Uplink TRXD PDU contains a demodulated burst with the associated measurements (signal strength, timing delay, etc.) and TDMA frame/timeslot number. Starting from TRXDv1, a PDU may contain no payload, indicating the upper layers that the transceiver was not able to demodulate a burst (e.g. due to bad signal quality or the lack of signal during IDLE TDMA frames).

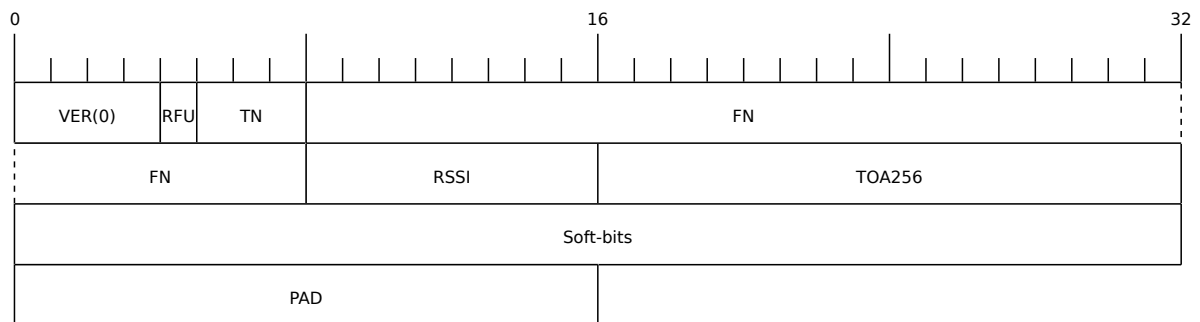

Figure 13: TRXDv0 Uplink data burst message structure

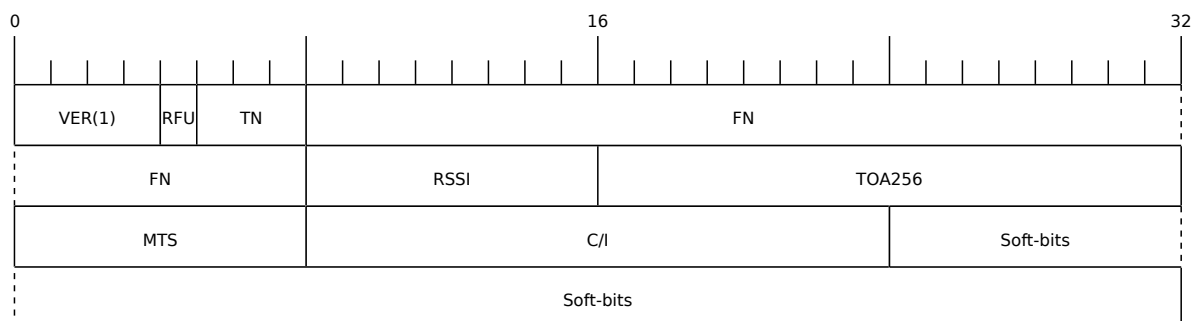

Figure 14: TRXDv1 Uplink data burst message structure

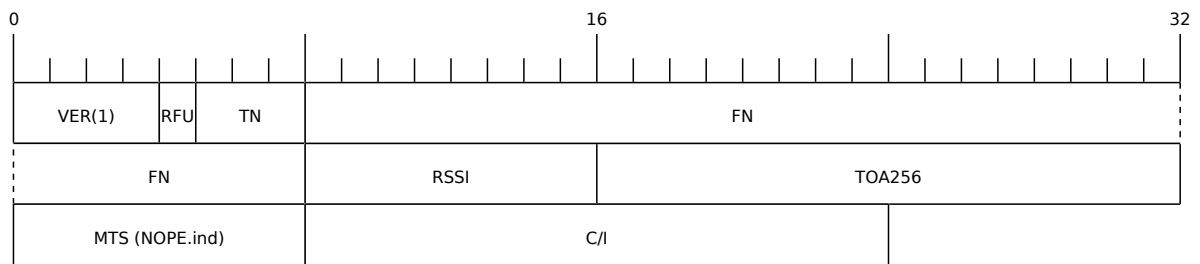

Figure 15: TRXDv1 NOPE / IDLE indication message structure

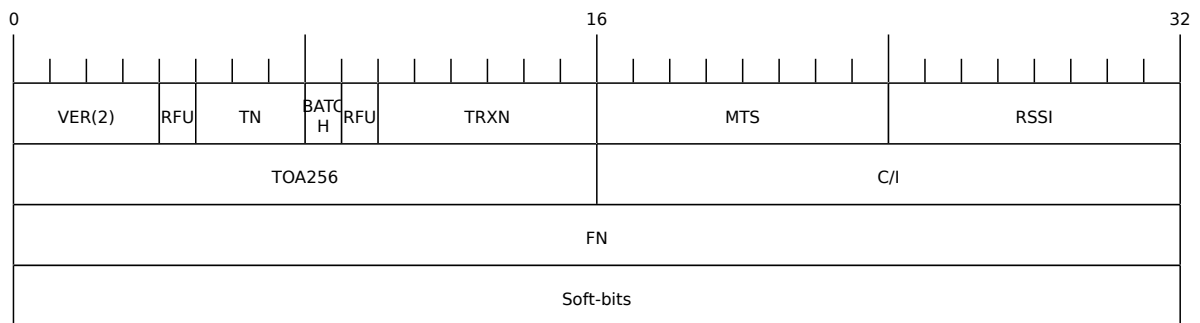

Figure 16: TRXDv2 Uplink message structure

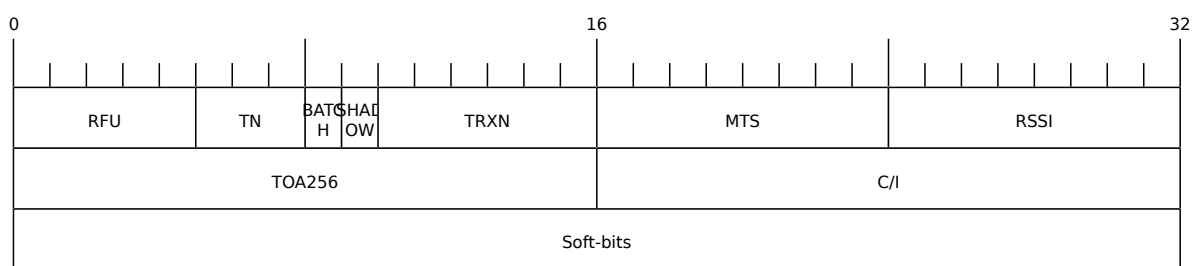

Figure 17: TRXDv2 Uplink message structure (batched part)

**VER: 4 bits**

TRXD header version, common for both TRX → L1 and L1 → TRX directions.

**TN: 3 bits**

Timeslot number.

**RFU: variable bit-length**

Reserved for Future Use. The sending side of the PDU shall set all bits to '0'B; the receiving side shall ignore RFU fields.

**BATCH: 1 bit**

This bit indicates whether a batched PDU follows (see Section 26.3.4).

**SHADOW: 1 bit**

This bit indicates whether this is a *shadow PDU* (see Section 26.3.5).

**TRXN: 6 bits**

The transceiver (PHY channel) number this PDU is coming from.

**FN: 32 bits (4 bytes)**

GSM frame number, big endian.

**RSSI: 8 bits (1 byte)**

Received Signal Strength Indication in -dBm, encoded without the negative sign.

**TOA256: 16 bits (2 bytes)**

Timing of Arrival in units of 1/256 of symbol, big endian.

**MTS: 8 bits (1 byte)**

Contains the Modulation and Training Sequence information. See Section 26.3.2.1 for more information on the encoding.

**C/I: 16 bits (2 bytes)**

Contains the Carrier-to-Interference ratio in centiBels, big endian. The C/I value is computed from the training sequence of each burst, where the "ideal" training sequence is compared to the actual training sequence and the result expressed in centiBels.

**Soft-bits: 148 x N bytes (variable length, N defined by modulation type)**

Contains the uplink burst. Unlike the downlink bursts, the uplink bursts are designated using the soft-bits notation, so the receiver can indicate its assurance from 0 to -127 that a given bit is 1, and from 0 to +127 that a given bit is 0. The Viterbi algorithm allows to approximate the original sequence of hard-bits (1 or 0) using these values. Each soft-bit (-127..127) of the burst is encoded as an unsigned value in range (0..255) respectively using the constant shift. This way:

- 0 → definite "0"
- 255 → definite "1".

**PAD: 2 bytes (optional)**

Padding at the end, historical reasons (OpenBTS inheritance). Bits can take any value, but 0 is preferred. Only expected on TRXDv0 headers.

**26.3.2.1 Coding of MTS: Modulation and Training Sequence info**

3GPP TS 45.002 version 15.1.0 defines several modulation types, and a few sets of training sequences for each type. The most common are GMSK and 8-PSK (which is used in EDGE).

**MTS field structure**

```

+-----+-----+
| 7 6 5 4 3 2 1 0 | bit numbers (value range) |
+-----+-----+
| X . . . . . | NOPE / IDLE frame indication (0 or 1) |
+-----+-----+
| . X X X X . . . | Modulation, TS set number (see below) |
+-----+-----+
| . . . . . X X X | Training / Synch. Sequence Code (0..7) |
+-----+-----+

```

**NOPE / IDLE frame indication (referred to as NOPE.ind)**

The bit number 7 (MSB) shall be set to '1'B by the transceiver when either nothing has been detected, so the BTS scheduler keeps processing bursts without gaps, or during IDLE frames, so the current noise levels can be delivered. In this case the remaining bits become meaningless and shall be set to '0'B. The payload (Soft-bits or Hard-bits) is omitted.

**Modulation and TS set number**

GMSK has 4 sets of training sequences (see tables 5.2.3a-d), while 8-PSK (see tables 5.2.3f-g) and the others have 2 sets. Access and Synchronization bursts also have several synchronization sequences.

**Modulation and TS set number**

7 6 5 4 3 2 1 0	Description	Burst length
. 0 0 X X . . .	GMSK, 4 TS sets (0..3)	148 x 1
. 0 1 0 X . . .	8-PSK, 2 TS sets (0..1)	148 x 3
. 0 1 1 0 . . .	GMSK, Access Burst (see note)	148 x 1
. 0 1 1 1 . . .	RFU (Reserved for Future Use)	-----
. 1 0 0 X . . .	16QAM, 2 TS sets (0..1)	148 x 4
. 1 0 1 X . . .	32QAM, 2 TS sets (0..1)	148 x 5
. 1 1 X X . . .	AQPSK (Downlink), 4 TS sets (0..3)	148 x 2

**Note**

A radio block on PDCH is carried by the sequence of four Normal Bursts. The one exception is a special radio block occasionally used on the Uplink consisting of a sequence of four Access Bursts (see 3GPP TS 44.060). The transceiver shall use 0110 as the modulation type to indicate that.

**Training / Synch. Sequence Code**

In combination with a modulation type and a TS set number, this field uniquely identifies the Training Sequence of a received Normal Burst (see tables 5.2.3a-d) or Synchronization Burst (see table 5.2.5-3), or the Synch. Sequence of a received Access Burst (see table 5.2.7-3 and 5.2.7-4).

**26.3.3 Downlink Data Burst**

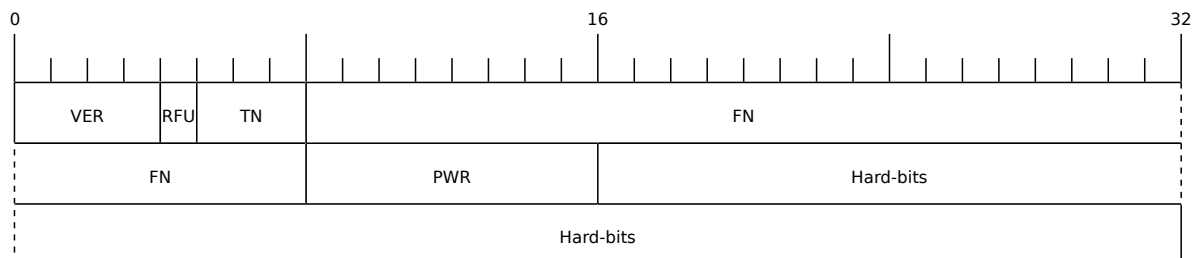

Figure 18: TRXDv0 and TRXDv1 Downlink data burst message structure

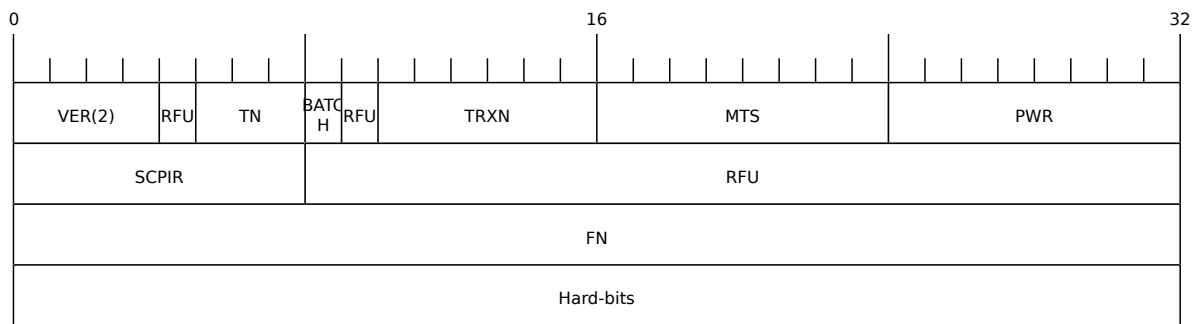

Figure 19: TRXDv2 Downlink data burst message structure

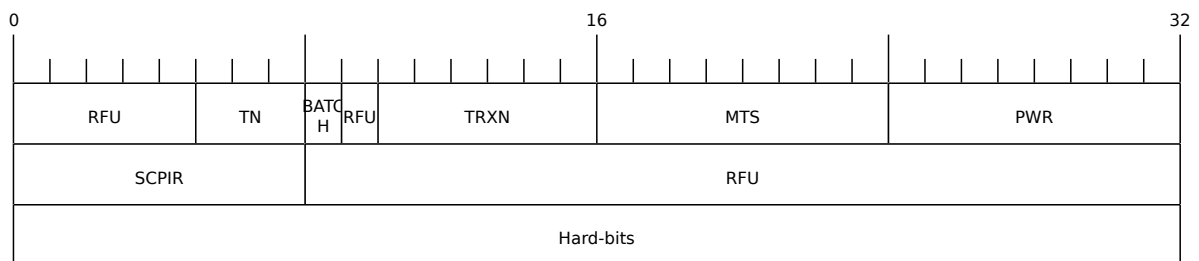

Figure 20: TRXDv2 Downlink PDU structure (batched part)

**VER: 4 bits**

TRXD header version, common for both TRX → L1 and L1 → TRX directions.

**TN: 3 bits**

Timeslot number.

**RFU: variable bit-length**

Reserved for Future Use. The sending side of the PDU shall set all bits to '0'B; the receiving side shall ignore RFU fields.

**BATCH: 1 bit**

This bit indicates whether a batched PDU follows (see Section 26.3.4).

**TRXN: 6 bits**

The transceiver (PHY channel) number this PDU is addressed to.

**MTS: 8 bits (1 byte)**

Contains the Modulation and Training Sequence information. See Section 26.3.2.1 for more information on the encoding.

**FN: 32 bits (4 bytes)**

GSM frame number, big endian.

**PWR: 8 bits (1 byte)**

Contains the relative (to the full-scale amplitude) transmit power **reduction** in dB. The absolute value is set on the control interface, so the resulting power is calculated as follows:  $full\_scale - (absolute\_red + relative\_red)$ .

**SCPIR: 8 bits (1 byte)**

SCPIR (Subchannel Power Imbalance Ratio) - the ratio of power between Q and I channels for a VAMOS pair. This field shall be present when MTC field indicates the use of AQP SK modulation. Otherwise, all bits shall be set to '0'B. The value is a signed integer with a valid range: -10..10 dB.

**Hard-bits: 148 x N bytes (variable length, N defined by modulation type)**

Contains the downlink burst. Each hard-bit (1 or 0) of the burst is represented using one byte (0x01 or 0x00 respectively).

**26.3.4 PDU batching**

Starting from TRXDv2, it's possible to combine several PDUs into a single datagram - this is called *PDU batching*. The purpose of *PDU batching* is to reduce socket load and eliminate possible PDU reordering, especially in a multi-TRX setup.

All *batched PDUs* in a datagram must belong to the same TDMA frame number indicated in the first part. The ordering of PDUs in a datagram may be different from the examples below, however it's recommended to batch PDUs in ascending order determined by TDMA timeslot number and/or TRXN.

The following PDU combinations in a datagram are possible:

- a) one datagram contains PDUs with the same TDMA timeslot number for all transceivers (total N PDUs per a TDMA timeslot);
- one datagram contains complete TDMA frame with PDUs for all 8 timeslots:
  - b) either for a single transceiver (total 8 PDUs per a TDMA frame),
  - c) or for all transceivers (total 8 x N PDUs per a TDMA frame).

None of these combinations are mandatory to support.

**Note**

Automatic negotiation of the batching algorithm(s) is not yet specified. Currently both sides need to be manually configured to use *PDU batching*.

**Note**

Size of the biggest possible TRXD datagram should be less than the *MTU (Maximum Transmission Unit)* of the network interface connecting both BTS and the transceiver. Otherwise the datagram is split across multiple IP packets, which may negatively affect performance.

**Example: datagram structure for combination a)**

```
+-----+-----+-----+-----+
| TRXN=0 | TDMA FN=F TN=T | BATCH=1 | Hard-/Soft-bits |
+-----+-----+-----+-----+
| TRXN=1 | TDMA FN=F TN=T | BATCH=1 | Hard-/Soft-bits |
+-----+-----+-----+-----+
| TRXN=2 | TDMA FN=F TN=T | BATCH=1 | Hard-/Soft-bits |
+-----+-----+-----+-----+
~~~~~~
+-----+-----+-----+-----+
| TRXN=N | TDMA FN=F TN=T | BATCH=0 | Hard-/Soft-bits |
+-----+-----+-----+-----+
```

**Example: datagram structure for combination b)**

```

+-----+-----+-----+-----+
| TRXN=N | TDMA FN=F TN=0 | BATCH=1 | Hard-/Soft-bits |
+-----+-----+-----+-----+
| TRXN=N | TDMA FN=F TN=1 | BATCH=1 | Hard-/Soft-bits |
+-----+-----+-----+-----+
| TRXN=N | TDMA FN=F TN=2 | BATCH=1 | Hard-/Soft-bits |
+-----+-----+-----+-----+
~~~~~
+-----+-----+-----+-----+
| TRXN=N | TDMA FN=F TN=7 | BATCH=0 | Hard-/Soft-bits |
+-----+-----+-----+-----+
    
```

**Example: datagram structure for combination c)**

```

+-----+-----+-----+-----+
| TRXN=0 | TDMA FN=F TN=0 | BATCH=1 | Hard-/Soft-bits |
+-----+-----+-----+-----+
| TRXN=0 | TDMA FN=F TN=1 | BATCH=1 | Hard-/Soft-bits |
+-----+-----+-----+-----+
| TRXN=0 | TDMA FN=F TN=2 | BATCH=1 | Hard-/Soft-bits |
+-----+-----+-----+-----+
~~~~~
+-----+-----+-----+-----+
| TRXN=N | TDMA FN=F TN=6 | BATCH=1 | Hard-/Soft-bits |
+-----+-----+-----+-----+
| TRXN=N | TDMA FN=F TN=7 | BATCH=0 | Hard-/Soft-bits |
+-----+-----+-----+-----+
    
```

**26.3.5 Coding of VAMOS PDUs**

In VAMOS mode, the throughput of a cell is increased by multiplexing two subscribers on a single TDMA timeslot. Basically, **two** bursts are getting transmitted during one TDMA timeslot period, and both of them need delivered over the TRXD interface.

In the Downlink direction, the two bursts belonging to a *VAMOS pair* shall be concatenated together and sent in one TRXD PDU. The resulting hard-bit sequence shall **not** be interleaved:  $V_0(0..147) + V_1(0..147)$  (296 hard-bits total), i.e. one complete burst for subscriber  $V_0$  takes the first 148 bytes, and another complete burst for subscriber  $V_1$  takes the remaining 148 bytes. The MTS field shall indicate the use of AQPSK modulation, and the SCPIR field shall indicate the Power Imbalance Ratio between  $V_0$  and  $V_1$ .

**Example: Downlink datagram containing a VAMOS PDU**

```

~~~~~
+-----+-----+-----+-----+
| TRXN=N | TDMA FN=F TN=T | Mod=AQPSK | Hard-bits: V0(0..147) + V1(0..147) |
+-----+-----+-----+-----+
~~~~~
    
```

In the Uplink direction though, one or even both of the two bursts may be lost (e.g. due to high noise figures), so they shall always be sent in two separate PDUs. The missing bursts shall be substituted by NOPE indications, so it's always a pair of *batched PDUs*. First PDU in a pair is called *primary PDU*, the second is called *shadow PDU*. This is additionally indicated by the SHADOW field, which is set to '0'B and '1'B, respectively. The MTS field shall indicate the use of GMSK modulation if the burst is present.

**Example: Uplink datagram containing batched VAMOS PDUs (both present)**

```

~~~~~
+-----+-----+-----+-----+
| TRXN=N | TDMA FN=F TN=T | SHADOW=0 | Mod=GMSK | Soft-bits for V0 (148 bytes) |
+-----+-----+-----+-----+
| TRXN=N | TDMA FN=F TN=T | SHADOW=1 | Mod=GMSK | Soft-bits for V1 (148 bytes) |
+-----+-----+-----+-----+
    
```



```

+-----+-----+-----+-----+-----+
~::~:~::~:~::~:~::~:~::~:~::~:~::~:~::~:~::~:~::~:~::~:~::~:~::~:~::~:~::~:~::~:~::~:~::~:~::~:~::~:~::~:~::~:~::~:~::~:

```

**Example: Uplink datagram containing batched VAMOS PDUs (one lost)**

```

~::~:~::~:~::~:~::~:~::~:~::~:~::~:~::~:~::~:~::~:~::~:~::~:~::~:~::~:~::~:~::~:~::~:~::~:~::~:~::~:~::~:~::~:~::~:
+-----+-----+-----+-----+-----+
| TRXN=N | TDMA FN=F TN=T | SHADOW=0 | Mod=GMSK | Soft-bits for V0 (148 bytes) |
+-----+-----+-----+-----+-----+
| TRXN=N | TDMA FN=F TN=T | SHADOW=1 | NOPE.ind |
+-----+-----+-----+-----+
~::~:~::~:~::~:~::~:~::~:~::~:~::~:~::~:~::~:~::~:~::~:~::~:~::~:~::~:~::~:~::~:~::~:~::~:~::~:~::~:~::~:~::~:~::~:

```

## 27 Osmocom Control Interface

The VTY interface as described in Section 12 is aimed at human interaction with the respective Osmocom program.

Other programs **should not** use the VTY interface to interact with the Osmocom software, as parsing the textual representation is cumbersome, inefficient, and will break every time the formatting is changed by the Osmocom developers.

Instead, the *Control Interface* was introduced as a programmatic interface that can be used to interact with the respective program.

### 27.1 Control Interface Protocol

The control interface protocol is a mixture of binary framing with text based payload.

The protocol for the control interface is wrapped inside the IPA multiplex header with the stream identifier set to IPAC\_PROTO\_OSMO (0xEE).

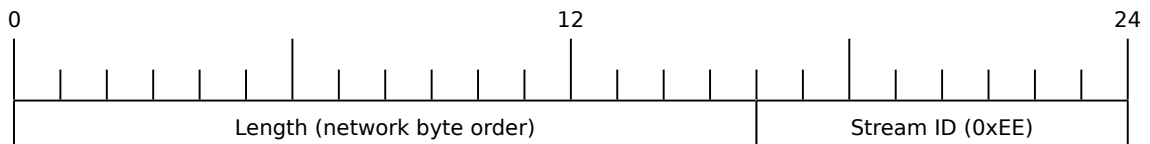

Figure 21: IPA header for control protocol

Inside the IPA header is a single byte of extension header with protocol ID 0x00 which indicates the control interface.

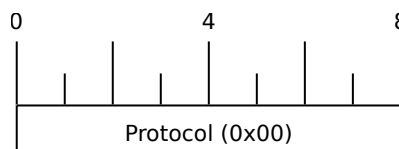

Figure 22: IPA extension header for control protocol

After the concatenation of the two above headers, the plain-text payload message starts. The format of that plain text is illustrated for each operation in the respective message sequence chart in the chapters below.

The fields specified below follow the following meaning:

**<id>**

A numeric identifier, uniquely identifying this particular operation. Value 0 is not allowed unless it's a TRAP message. It will be echoed back in any response to a particular request.

**<var>**

The name of the variable / field affected by the GET / SET / TRAP operation. Which variables/fields are available is dependent on the specific application under control.

**<val>**

The value of the variable / field

**<reason>**

A text formatted, human-readable reason why the operation resulted in an error.

### 27.1.1 GET operation

The GET operation is performed by an external application to get a certain value from inside the Osmocom application.

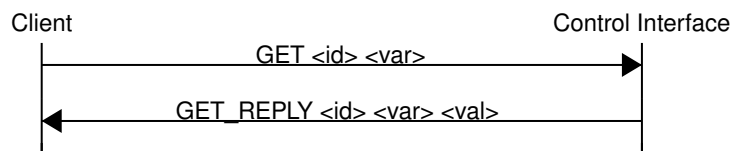

Figure 23: Control Interface GET operation (successful outcome)

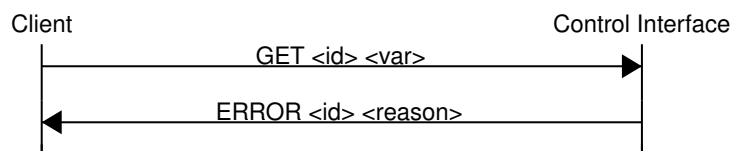

Figure 24: Control Interface GET operation (unsuccessful outcome)

### 27.1.2 SET operation

The SET operation is performed by an external application to set a value inside the Osmocom application.

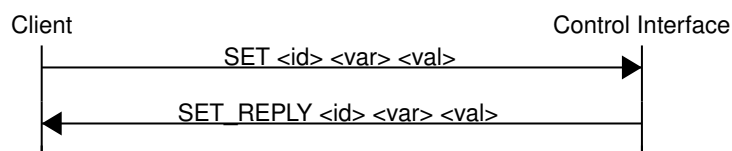

Figure 25: Control Interface SET operation (successful outcome)

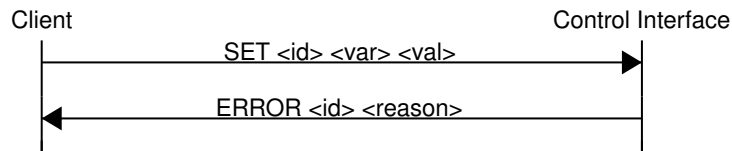

Figure 26: Control Interface SET operation (unsuccessful outcome)

### 27.1.3 TRAP operation

The program can at any time issue a trap. The term is used in the spirit of SNMP.

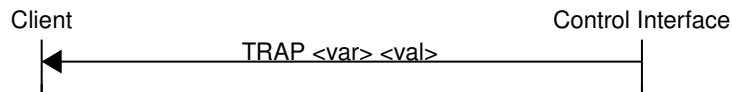

Figure 27: Control Interface TRAP operation

## 27.2 Common variables

There are several variables which are common to all the programs using control interface. They are described in the following table.

Table 14: Variables available over control interface

Name	Access	Value	Comment
counter.*	RO		Get counter value.
rate_ctr.*	RO		Get list of rate counter groups.
rate_ctr.IN.GN.GI.name	RO		Get value for interval IN of rate counter name which belong to group named GN with index GI.

Those read-only variables allow to get value of arbitrary counter using its name.

For example "rate\_ctr.per\_hour.bsc.0.handover:timeout" is the number of handover timeouts per hour.

Of course for that to work the program in question have to register corresponding counter names and groups using libosmocore functions.

In the example above, "bsc" is the rate counter group name and "0" is its index. It is possible to obtain all the rate counters in a given group by requesting "rate\_ctr.per\_sec.bsc.\*" variable.

The list of available groups can be obtained by requesting "rate\_ctr.\*" variable.

The rate counter group name have to be prefixed with interval specification which can be any of "per\_sec", "per\_min", "per\_hour", "per\_day" or "abs" for absolute value.

The old-style counters available via "counter.\*" variables are superseded by "rate\_ctr.abs" so its use is discouraged. There might still be some applications not yet converted to rate\_ctr.

## 27.3 Control Interface python examples

In the `osmo-python-tests` repository, there is an example python script called `scripts/osmo_ctrl.py` which implements the Osmocom control interface protocol.

You can use this tool either stand-alone to perform control interface operations against an Osmocom program, or you can use it as a reference for developing your own python software talking to the control interface.

Another implementation is in `scripts/osmo_rate_ctr2csv.py` which will retrieve performance counters for a given Osmocom program and output it in csv format. This can be used to periodically (using `systemd timer` for example) retrieve data to build KPI and evaluate how it changes over time.

Internally it uses `"rate_ctr.*"` variable described in Section 27.2 to get the list of counter groups and then request all the counters in each group. Applications interested in individual metrics can request it directly using `rate_ctr2csv.py` as an example.

### 27.3.1 Getting rate counters

#### Example: Use `rate_ctr2csv.py` to get rate counters from OsmoBSC

```
$ ./scripts/osmo_rate_ctr2csv.py --header
Connecting to localhost:4249...
Getting rate counter groups info...
"group","counter","absolute","second","minute","hour","day"
"elinp.0","hdlc:abort","0","0","0","0","0"
"elinp.0","hdlc:bad_fcs","0","0","0","0","0"
"elinp.0","hdlc:overrun","0","0","0","0","0"
"elinp.0","alarm","0","0","0","0","0"
"elinp.0","removed","0","0","0","0","0"
"bsc.0","chreq:total","0","0","0","0","0"
"bsc.0","chreq:no_channel","0","0","0","0","0"
...
"msc.0","call:active","0","0","0","0","0"
"msc.0","call:complete","0","0","0","0","0"
"msc.0","call:incomplete","0","0","0","0","0"
Completed: 44 counters from 3 groups received.
```

### 27.3.2 Setting a value

#### Example: Use `osmo_ctrl.py` to set the short network name of OsmoBSC

```
$ ./osmo_ctrl.py -d localhost -s short-name 32C3
Got message: SET_REPLY 1 short-name 32C3
```

### 27.3.3 Getting a value

#### Example: Use `osmo_ctrl.py` to get the mnc of OsmoBSC

```
$ ./osmo_ctrl.py -d localhost -g mnc
Got message: GET_REPLY 1 mnc 262
```

### 27.3.4 Listening for traps

You can use `osmo_ctrl.py` to listen for traps the following way:

#### Example: Using `osmo_ctrl.py` to listen for traps:

```
$ ./osmo_ctrl.py -d localhost -m
```

- ❶ the command will not return and wait for any TRAP messages to arrive

## 28 Glossary

### 2FF

2nd Generation Form Factor; the so-called plug-in SIM form factor

### 3FF

3rd Generation Form Factor; the so-called microSIM form factor

### 3GPP

3rd Generation Partnership Project

### 4FF

4th Generation Form Factor; the so-called nanoSIM form factor

### A Interface

Interface between BTS and BSC, traditionally over E1 (*3GPP TS 48.008* [[3gpp-ts-48-008](#)])

### A3/A8

Algorithm 3 and 8; Authentication and key generation algorithm in GSM and GPRS, typically COMP128v1/v2/v3 or MILENAGE are typically used

### A5

Algorithm 5; Air-interface encryption of GSM; currently only A5/0 (no encryption), A5/1 and A5/3 are in use

### Abis Interface

Interface between BTS and BSC, traditionally over E1 (*3GPP TS 48.058* [[3gpp-ts-48-058](#)] and *3GPP TS 52.021* [[3gpp-ts-52-021](#)])

### ACC

Access Control Class; every BTS broadcasts a bit-mask of permitted ACC, and only subscribers with a SIM of matching ACC are permitted to use that BTS

### AGCH

Access Grant Channel on Um interface; used to assign a dedicated channel in response to RACH request

### AGPL

GNU Affero General Public License, a copyleft-style Free Software License

### AQPSK

Adaptive QPSK, a modulation scheme used by VAMOS channels on Downlink

### ARFCN

Absolute Radio Frequency Channel Number; specifies a tuple of uplink and downlink frequencies

### AUC

Authentication Center; central database of authentication key material for each subscriber

### BCCH

Broadcast Control Channel on Um interface; used to broadcast information about Cell and its neighbors

### BCC

Base Station Color Code; short identifier of BTS, lower part of BSIC

**BTS**

Base Transceiver Station

**BSC**

Base Station Controller

**BSIC**

Base Station Identity Code; 16bit identifier of BTS within location area

**BSSGP**

Base Station Subsystem Gateway Protocol (*3GPP TS 48.018* [[3gpp-ts-48-018](#)])

**BVCI**

BSSGP Virtual Circuit Identifier

**CBC**

Cell Broadcast Centre; central entity of Cell Broadcast service

**CBCH**

Cell Broadcast Channel; used to transmit Cell Broadcast SMS (SMS-CB)

**CBS**

Cell Broadcast Service

**CBSP**

Cell Broadcast Service Protocol (*3GPP TS 48.049* [[3gpp-ts-48-049](#)])

**CC**

Call Control; Part of the GSM Layer 3 Protocol

**CCCH**

Common Control Channel on Um interface; consists of RACH (uplink), BCCH, PCH, AGCH (all downlink)

**Cell**

A cell in a cellular network, served by a BTS

**CEPT**

Conférence européenne des administrations des postes et des télécommunications; European Conference of Postal and Telecommunications Administrations.

**CGI**

Cell Global Identifier comprised of MCC, MNC, LAC and BSIC

**CSFB**

Circuit-Switched Fall Back; Mechanism for switching from LTE/EUTRAN to UTRAN/GERAN when circuit-switched services such as voice telephony are required.

**dB**

deci-Bel; relative logarithmic unit

**dBm**

deci-Bel (milliwatt); unit of measurement for signal strength of radio signals

**DHCP**

Dynamic Host Configuration Protocol (*IETF RFC 2131* [[ietf-rfc2131](#)])

**downlink**

Direction of messages / signals from the network core towards the mobile phone

**DSCP**

Differentiated Services Code Point (*IETF RFC 2474* [[ietf-rfc2474](#)])

**DSP**

Digital Signal Processor

**dnixload**

Tool to program UBL and the Bootloader on a sysmoBTS

**EDGE**

Enhanced Data rates for GPRS Evolution; Higher-speed improvement of GPRS; introduces 8PSK

**EGPRS**

Enhanced GPRS; the part of EDGE relating to GPRS services

**EIR**

Equipment Identity Register; core network element that stores and manages IMEI numbers

**ESME**

External SMS Entity; an external application interfacing with a SMSC over SMPP

**ETSI**

European Telecommunications Standardization Institute

**FPGA**

Field Programmable Gate Array; programmable digital logic hardware

**Gb**

Interface between PCU and SGSN in GPRS/EDGE network; uses NS, BSSGP, LLC

**GERAN**

GPRS/EDGE Radio Access Network

**GFDL**

GNU Free Documentation License; a copyleft-style Documentation License

**GGSN**

GPRS Gateway Support Node; gateway between GPRS and external (IP) network

**GMSK**

Gaussian Minimum Shift Keying; modulation used for GSM and GPRS

**GPL**

GNU General Public License, a copyleft-style Free Software License

**Gp**

Gp interface between SGSN and GGSN; uses GTP protocol

**GPRS**

General Packet Radio Service; the packet switched 2G technology

**GPS**

Global Positioning System; provides a highly accurate clock reference besides the global position

**GSM**

Global System for Mobile Communications. ETSI/3GPP Standard of a 2G digital cellular network

**GSMTAP**

GSM tap; pseudo standard for encapsulating GSM protocol layers over UDP/IP for analysis

**GSUP**

Generic Subscriber Update Protocol. Osmocom-specific alternative to TCAP/MAP

**GT**

Global Title; an address in SCCP

**GTP**

GPRS Tunnel Protocol; used between SGSN and GGSN

**HLR**

Home Location Register; central subscriber database of a GSM network

**HNB-GW**

Home NodeB Gateway. Entity between femtocells (Home NodeB) and CN in 3G/UMTS.

**HPLMN**

Home PLMN; the network that has issued the subscriber SIM and has his record in HLR

**IE**

Information Element

**IMEI**

International Mobile Equipment Identity; unique 14-digit decimal number to globally identify a mobile device, optionally with a 15th checksum digit

**IMEISV**

IMEI software version; unique 14-digit decimal number to globally identify a mobile device (same as IMEI) plus two software version digits (total digits: 16)

**IMSI**

International Mobile Subscriber Identity; 15-digit unique identifier for the subscriber/SIM; starts with MCC/MNC of issuing operator

**IP**

Internet Protocol (*IETF RFC 791* [[ietf-rfc791](#)])

**IPA**

*ip.access GSM over IP* protocol; used to multiplex a single TCP connection

**Iu**

Interface in 3G/UMTS between RAN and CN

**IuCS**

Iu interface for circuit-switched domain. Used in 3G/UMTS between RAN and MSC

**IuPS**

Iu interface for packet-switched domain. Used in 3G/UMTS between RAN and SGSN

**LAC**

Location Area Code; 16bit identifier of Location Area within network

**LAPD**

Link Access Protocol, D-Channel (*ITU-T Q.921* [[itu-t-q921](#)])

**LAPDm**

Link Access Protocol Mobile (*3GPP TS 44.006* [[3gpp-ts-44-006](#)])

**LLC**

Logical Link Control; GPRS protocol between MS and SGSN (*3GPP TS 44.064* [[3gpp-ts-44-064](#)])

**Location Area**

Location Area; a geographic area containing multiple BTS

**LU**

Location Updating; can be of type IMSI-Attach or Periodic. Procedure that indicates a subscriber's physical presence in a given radio cell.

**M2PA**

MTP2 Peer-to-Peer Adaptation; a SIGTRAN Variant (*RFC 4165* [[ietf-rfc4165](#)])

**M2UA**

MTP2 User Adaptation; a SIGTRAN Variant (*RFC 3331* [[ietf-rfc3331](#)])

**M3UA**

MTP3 User Adaptation; a SIGTRAN Variant (*RFC 4666* [[ietf-rfc4666](#)])



**MCC**

Mobile Country Code; unique identifier of a country, e.g. 262 for Germany

**MFF**

Machine-to-Machine Form Factor; a SIM chip package that is soldered permanently onto M2M device circuit boards.

**MGW**

Media Gateway

**MM**

Mobility Management; part of the GSM Layer 3 Protocol

**MNC**

Mobile Network Code; identifies network within a country; assigned by national regulator

**MNCC**

Mobile Network Call Control; Unix domain socket based Interface between MSC and external call control entity like osmo-sip-connector

**MNO**

Mobile Network Operator; operator with physical radio network under his MCC/MNC

**MO**

Mobile Originated. Direction from Mobile (MS/UE) to Network

**MS**

Mobile Station; a mobile phone / GSM Modem

**MSC**

Mobile Switching Center; network element in the circuit-switched core network

**MSC pool**

A number of redundant MSCs serving the same core network, which a BSC / RNC distributes load across; see also the "MSC Pooling" chapter in OsmoBSC's user manual [\[userman-osmobsc\]](#) and *3GPP TS 23.236* [\[3gpp-ts-23-236\]](#)

**MSISDN**

Mobile Subscriber ISDN Number; telephone number of the subscriber

**MT**

Mobile Terminated. Direction from Network to Mobile (MS/UE)

**MTP**

Message Transfer Part; SS7 signaling protocol (*ITU-T Q.701* [\[itu-t-q701\]](#))

**MVNO**

Mobile Virtual Network Operator; Operator without physical radio network

**NCC**

Network Color Code; assigned by national regulator

**NITB**

Network In The Box; combines functionality traditionally provided by BSC, MSC, VLR, HLR, SMSC functions; see OsmoNITB

**NRI**

Network Resource Indicator, typically 10 bits of a TMSI indicating which MSC of an MSC pool attached the subscriber; see also the "MSC Pooling" chapter in OsmoBSC's user manual [\[userman-osmobsc\]](#) and *3GPP TS 23.236* [\[3gpp-ts-23-236\]](#)

**NSEI**

NS Entity Identifier

**NVCI**

NS Virtual Circuit Identifier

**NWL**

Network Listen; ability of some BTS to receive downlink from other BTSs

**NS**

Network Service; protocol on Gb interface (*3GPP TS 48.016* [[3gpp-ts-48-016](#)])

**OCXO**

Oven Controlled Crystal Oscillator; very high precision oscillator, superior to a VCTCXO

**OML**

Operation & Maintenance Link (*ETSI/3GPP TS 52.021* [[3gpp-ts-52-021](#)])

**OpenBSC**

Open Source implementation of GSM network elements, specifically OsmoBSC, OsmoNITB, OsmoSGSN

**OpenGGSN**

Open Source implementation of a GPRS Packet Control Unit

**OpenVPN**

Open-Source Virtual Private Network; software employed to establish encrypted private networks over untrusted public networks

**Osmocom**

Open Source MOBILE COMmunications; collaborative community for implementing communications protocols and systems, including GSM, GPRS, TETRA, DECT, GMR and others

**OsmoBSC**

Open Source implementation of a GSM Base Station Controller

**OsmoNITB**

Open Source implementation of a GSM Network In The Box, combines functionality traditionally provided by BSC, MSC, VLR, HLR, AUC, SMSC

**OsmoSGSN**

Open Source implementation of a Serving GPRS Support Node

**OsmoPCU**

Open Source implementation of a GPRS Packet Control Unit

**OTA**

Over-The-Air; Capability of operators to remotely reconfigure/reprogram ISM/USIM cards

**PC**

Point Code; an address in MTP

**PCH**

Paging Channel on downlink Um interface; used by network to page an MS

**PCP**

Priority Code Point (*IEEE 802.1Q* [?])

**PCU**

Packet Control Unit; used to manage Layer 2 of the GPRS radio interface

**PDCH**

Packet Data Channel on Um interface; used for GPRS/EDGE signalling + user data

**PIN**

Personal Identification Number; a number by which the user authenticates to a SIM/USIM or other smart card

**PLMN**

Public Land Mobile Network; specification language for a single GSM network

**PUK**

PIN Unblocking Code; used to unblock a blocked PIN (after too many wrong PIN attempts)

**RAC**

Routing Area Code; 16bit identifier for a Routing Area within a Location Area

**RACH**

Random Access Channel on uplink Um interface; used by MS to request establishment of a dedicated channel

**RAM**

Remote Application Management; Ability to remotely manage (install, remove) Java Applications on SIM/USIM Card

**RF**

Radio Frequency

**RFM**

Remote File Management; Ability to remotely manage (write, read) files on a SIM/USIM card

**Roaming**

Procedure in which a subscriber of one network is using the radio network of another network, often in different countries; in some countries national roaming exists

**Routing Area**

Routing Area; GPRS specific sub-division of Location Area

**RR**

Radio Resources; Part of the GSM Layer 3 Protocol

**RSL**

Radio Signalling Link (*3GPP TS 48.058* [[3gpp-ts-48-058](#)])

**RTP**

Real-Time Transport Protocol (*IETF RFC 3550* [[ietf-rfc3550](#)]); Used to transport audio/video streams over UDP/IP

**SACCH**

Slow Associate Control Channel on Um interface; bundled to a TCH or SDCCH, used for signalling in parallel to active dedicated channel

**SCCP**

Signaling Connection Control Part; SS7 signaling protocol (*ITU-T Q.711* [[itu-t-q711](#)])

**SDCCH**

Slow Dedicated Control Channel on Um interface; used for signalling and SMS transport in GSM

**SDK**

Software Development Kit

**SGs**

Interface between MSC (GSM/UMTS) and MME (LTE/EPC) to facilitate CSFB and SMS.

**SGSN**

Serving GPRS Support Node; Core network element for packet-switched services in GSM and UMTS.

**SIGTRAN**

Signaling Transport over IP (*IETF RFC 2719* [[ietf-rfc2719](#)])

**SIM**

Subscriber Identity Module; small chip card storing subscriber identity

**Site**

A site is a location where one or more BTSs are installed, typically three BTSs for three sectors

**SMPP**

Short Message Peer-to-Peer; TCP based protocol to interface external entities with an SMSC

**SMSC**

Short Message Service Center; store-and-forward relay for short messages

**SS7**

Signaling System No. 7; Classic digital telephony signaling system

**SS**

Supplementary Services; query and set various service parameters between subscriber and core network (e.g. USSD, 3rd-party calls, hold/retrieve, advice-of-charge, call deflection)

**SSH**

Secure Shell; *IETF RFC 4250* [[ietf-rfc4251](#)] to 4254

**SSN**

Sub-System Number; identifies a given SCCP Service such as MSC, HLR

**STP**

Signaling Transfer Point; A Router in SS7 Networks

**SUA**

SCCP User Adaptation; a SIGTRAN Variant (*RFC 3868* [[ietf-rfc3868](#)])

**syslog**

System logging service of UNIX-like operating systems

**System Information**

A set of downlink messages on the BCCH and SACCH of the Um interface describing properties of the cell and network

**TCH**

Traffic Channel; used for circuit-switched user traffic (mostly voice) in GSM

**TCP**

Transmission Control Protocol; (*IETF RFC 793* [[ietf-rfc793](#)])

**TFTP**

Trivial File Transfer Protocol; (*IETF RFC 1350* [[ietf-rfc1350](#)])

**TOS**

Type Of Service; bit-field in IPv4 header, now re-used as DSCP (*IETF RFC 791* [[ietf-rfc791](#)])

**TRX**

Transceiver; element of a BTS serving a single carrier

**TS**

Technical Specification

**u-Boot**

Boot loader used in various embedded systems

**UBI**

An MTD wear leveling system to deal with NAND flash in Linux

**UBL**

Initial bootloader loaded by the TI Davinci SoC

**UDP**

User Datagram Protocol (*IETF RFC 768* [[ietf-rfc768](#)])

**UICC**

Universal Integrated Chip Card; A smart card according to *ETSI TR 102 216* [[etsi-tr102216](#)]

**Um interface**

U mobile; Radio interface between MS and BTS

**uplink**

Direction of messages: Signals from the mobile phone towards the network

**USIM**

Universal Subscriber Identity Module; application running on a UICC to provide subscriber identity for UMTS and GSM networks

**USSD**

Unstructured Supplementary Service Data; textual dialog between subscriber and core network, e.g. *\*100 → Your extension is 1234*

**VAMOS**

Voice services over Adaptive Multi-user channels on One Slot; an optional extension for GSM specified in Release 9 of 3GPP GERAN specifications (*3GPP TS 48.018 [3gpp-ts-48-018]*) allowing two independent UEs to transmit and receive simultaneously on traffic channels

**VCTCXO**

Voltage Controlled, Temperature Compensated Crystal Oscillator; a precision oscillator, superior to a classic crystal oscillator, but inferior to an OCXO

**VLAN**

Virtual LAN in the context of Ethernet (*IEEE 802.1Q [ieee-802.1q]*)

**VLR**

Visitor Location Register; volatile storage of attached subscribers in the MSC

**VPLMN**

Visited PLMN; the network in which the subscriber is currently registered; may differ from HPLMN when on roaming

**VTY**

Virtual Teletype; a textual command-line interface for configuration and introspection, e.g. the OsmoBSC configuration file as well as its telnet link on port 4242

## A Osmocom TCP/UDP Port Numbers

The Osmocom GSM system utilizes a variety of TCP/IP based protocols. The table below provides a reference as to which port numbers are used by which protocol / interface.

Table 15: TCP/UDP port numbers

L4 Protocol	Port Number	Purpose	Software
UDP	1984	Osmux	osmo-mgw, osmo-bts
UDP	2427	MGCP GW	osmo-bsc_mgcp, osmo-mgw
TCP	2775	SMPP (SMS interface for external programs)	osmo-nitb
TCP	3002	A-bis/IP OML	osmo-bts, osmo-bsc, osmo-nitb
TCP	3003	A-bis/IP RSL	osmo-bts, osmo-bsc, osmo-nitb
TCP	4227	telnet (VTY)	osmo-pcap-client
TCP	4228	telnet (VTY)	osmo-pcap-server
TCP	4236	Control Interface	osmo-trx
TCP	4237	telnet (VTY)	osmo-trx
TCP	4238	Control Interface	osmo-bts
TCP	4239	telnet (VTY)	osmo-stp
TCP	4240	telnet (VTY)	osmo-pcu
TCP	4241	telnet (VTY)	osmo-bts
TCP	4242	telnet (VTY)	osmo-nitb, osmo-bsc, cellmgr-ng
TCP	4243	telnet (VTY)	osmo-bsc_mgcp, osmo-mgw

Table 15: (continued)

L4 Protocol	Port Number	Purpose	Software
TCP	4244	telnet (VTY)	osmo-bsc_nat
TCP	4245	telnet (VTY)	osmo-sgsn
TCP	4246	telnet (VTY)	osmo-gbproxy
TCP	4247	telnet (VTY)	OsmocomBB
TCP	4249	Control Interface	osmo-nitb, osmo-bsc
TCP	4250	Control Interface	osmo-bsc_nat
TCP	4251	Control Interface	osmo-sgsn
TCP	4252	telnet (VTY)	sysmobts-mgr
TCP	4253	telnet (VTY)	osmo-gtphub
TCP	4254	telnet (VTY)	osmo-msc
TCP	4255	Control Interface	osmo-msc
TCP	4256	telnet (VTY)	osmo-sip-connector
TCP	4257	Control Interface	osmo-ggsn, ggsn (OpenGGSN)
TCP	4258	telnet (VTY)	osmo-hlr
TCP	4259	Control Interface	osmo-hlr
TCP	4260	telnet (VTY)	osmo-ggsn
TCP	4261	telnet (VTY)	osmo-hnbgw
TCP	4262	Control Interface	osmo-hnbgw
TCP	4263	Control Interface	osmo-gbproxy
TCP	4264	telnet (VTY)	osmo-cbc
TCP	4265	Control Interface	osmo-cbc
TCP	4266	D-GSM MS Lookup: mDNS serve	osmo-hlr
TCP	4267	Control Interface	osmo-mgw
TCP	4268	telnet (VTY)	osmo-uecups
SCTP	4268	UECUPS	osmo-uecups
TCP	4269	telnet (VTY)	osmo-eld
TCP	4270	telnet (VTY)	osmo-isdntap
TCP	4271	telnet (VTY)	osmo-smlc
TCP	4272	Control Interface	osmo-smlc
TCP	4273	telnet (VTY)	osmo-hnodeb
TCP	4274	Control Interface	osmo-hnodeb
TCP	4275	telnet (VTY)	osmo-upf
TCP	4276	Control Interface	osmo-upf
TCP	4277	telnet (VTY)	osmo-pfcp-tool
TCP	4278	Control Interface	osmo-pfcp-tool
UDP	4729	GSMTAP	Almost every osmocom project
TCP	5000	A/IP	osmo-bsc, osmo-bsc_nat
UDP	23000	GPRS-NS over IP default port	osmo-pcu, osmo-sgsn, osmo-gbproxy
TCP	48049	BSC-CBC (CBSP) default port	osmo-bsc, osmo-cbc

## B Bibliography / References

### B.0.0.0.1 References

- [1] [userman-ice1usb] Osmocom Project: icE1usb User Manual.
- [2] [userman-ogt] Pau Espin: osmo-gsm-tester User Manual.
- [3] [userman-remsim] Harald Welte: osmo-remsim User Manual.

- [4] [osmobts-abis-spec] Neels Hofmeyr & Harald Welte. OsmoBTS Abis Protocol Specification. <https://ftp.osmocom.org/docs/latest/osmobts-abis.pdf>
- [5] [userman-osmobsc] Osmocom Project: OsmoBSC User Manual. <https://ftp.osmocom.org/docs/latest/osmobsc-usermanual.pdf>
- [6] [vty-ref-osmobsc] Osmocom Project: OsmoBSC VTY Reference Manual. <https://ftp.osmocom.org/docs/latest/osmobsc-vty-reference.pdf>
- [7] [userman-osmobts] Osmocom Project: OsmoBTS User Manual. <https://ftp.osmocom.org/docs/latest/osmobts-usermanual.pdf>
- [8] [vty-ref-osmobts] Osmocom Project: OsmoBTS VTY Reference Manual. <https://ftp.osmocom.org/docs/latest/osmobts-trx-vty-reference.pdf> <https://ftp.osmocom.org/docs/latest/osmobts-sysmo-vty-reference.pdf> <https://ftp.osmocom.org/docs/latest/osmobts-1c15-vty-reference.pdf> <https://ftp.osmocom.org/docs/latest/osmobts-oc2g-vty-reference.pdf> <https://ftp.osmocom.org/docs/latest/osmobts-octphy-vty-reference.pdf> <https://ftp.osmocom.org/docs/latest/osmobts-virtual-vty-reference.pdf>
- [9] [userman-osmocbc] Osmocom Project: OsmoCBC User Manual. <https://ftp.osmocom.org/docs/latest/osmocbc-usermanual.pdf>
- [10] [vty-ref-osmocbc] Osmocom Project: OsmoCBC VTY Reference Manual. <https://ftp.osmocom.org/docs/latest/osmocbc-vty-reference.pdf>
- [11] [userman-osmogbproxy] Osmocom Project: OsmoGBProxy User Manual. <https://ftp.osmocom.org/docs/latest/osmogbproxy-usermanual.pdf>
- [12] [vty-ref-osmogbproxy] Osmocom Project: OsmoGBProxy VTY Reference Manual. <https://ftp.osmocom.org/docs/latest/osmogbproxy-vty-reference.pdf>
- [13] [userman-osmoggsn] Osmocom Project: OpenGGSN User Manual. <https://ftp.osmocom.org/docs/latest/osmoggsn-usermanual.pdf>
- [14] [vty-ref-osmoggsn] Osmocom Project: OsmoGGSN VTY Reference Manual. <https://ftp.osmocom.org/docs/latest/osmoggsn-vty-reference.pdf>
- [15] [userman-osmohlr] Osmocom Project: OsmoHLR User Manual. <https://ftp.osmocom.org/docs/latest/osmohlr-usermanual.pdf>
- [16] [vty-ref-osmohlr] Osmocom Project: OsmoHLR VTY Reference Manual. <https://ftp.osmocom.org/docs/latest/osmohlr-vty-reference.pdf>
- [17] [userman-osmohnbgw] Osmocom Project: OsmoHNBGW User Manual. <https://ftp.osmocom.org/docs/latest/osmohnbgw-usermanual.pdf>
- [18] [vty-ref-osmohnbgw] Osmocom Project: OsmoHNBGW VTY Reference Manual. <https://ftp.osmocom.org/docs/latest/osmohnbgw-vty-reference.pdf>
- [19] [userman-osmomgw] Osmocom Project: OsmoMGW User Manual. <https://ftp.osmocom.org/docs/latest/osmomgw-usermanual.pdf>
- [20] [vty-ref-osmomgw] Osmocom Project: OsmoMGW VTY Reference Manual. <https://ftp.osmocom.org/docs/latest/osmomgw-vty-reference.pdf>
- [21] [userman-osmomsc] Osmocom Project: OsmoMSC User Manual. <https://ftp.osmocom.org/docs/latest/osmomsc-usermanual.pdf>
- [22] [vty-ref-osmomsc] Osmocom Project: OsmoMSC VTY Reference Manual. <https://ftp.osmocom.org/docs/latest/osmomsc-vty-reference.pdf>
- [23] [userman-osmonitb] Osmocom Project: OsmoNITB User Manual. <https://ftp.osmocom.org/docs/latest/osmonitb-usermanual.pdf>

- [24] [vty-ref-osmonitb] Osmocom Project: OsmoNITB VTY Reference Manual. <https://ftp.osmocom.org/docs/latest/osmonitb-vty-reference.pdf>
- [25] [userman-osmopcu] Osmocom Project: OsmoPCU User Manual. <https://ftp.osmocom.org/docs/latest-osmopcu-usermanual.pdf>
- [26] [vty-ref-osmopcu] Osmocom Project: OsmoPCU VTY Reference Manual. <https://ftp.osmocom.org/docs/latest/osmopcu-vty-reference.pdf>
- [27] [userman-osmosgsn] Osmocom Project: OsmoSGSN User Manual. <https://ftp.osmocom.org/docs/latest-osmosgsn-usermanual.pdf>
- [28] [vty-ref-osmosgsn] Osmocom Project: OsmoSGSN VTY Reference Manual. <https://ftp.osmocom.org/docs/latest/osmosgsn-vty-reference.pdf>
- [29] [userman-osmosipconnector] Osmocom Project: OsmoSIPconnector User Manual. <https://ftp.osmocom.org/docs/latest/osmosipconnector-usermanual.pdf>
- [30] [vty-ref-osmosipconnector] Osmocom Project: OsmoSIPconnector VTY Reference Manual. <https://ftp.osmocom.org/docs/latest/osmosipconnector-vty-reference.pdf>
- [31] [userman-osmosmlc] Osmocom Project: OsmoSMLC User Manual. <https://ftp.osmocom.org/docs/latest-osmosmlc-usermanual.pdf>
- [32] [vty-ref-osmosmlc] Osmocom Project: OsmoSMLC VTY Reference Manual. <https://ftp.osmocom.org/docs/latest/osmosmlc-vty-reference.pdf>
- [33] [userman-osmostp] Osmocom Project: OsmoSTP User Manual. <https://ftp.osmocom.org/docs/latest/osmostp-usermanual.pdf>
- [34] [vty-ref-osmostp] Osmocom Project: OsmoSTP VTY Reference Manual. <https://ftp.osmocom.org/docs/latest-osmostp-vty-reference.pdf>
- [35] [userman-osmotrx] Osmocom Project: OsmoTRX User Manual. <https://ftp.osmocom.org/docs/latest/osmotrx-usermanual.pdf>
- [36] [vty-ref-osmotrx] Osmocom Project: OsmoTRX VTY Reference Manual. <https://ftp.osmocom.org/docs/latest/osmotrx-uhd-vty-reference.pdf> <https://ftp.osmocom.org/docs/latest/osmotrx-lms-vty-reference.pdf> <https://ftp.osmocom.org/docs/latest/osmotrx-ipc-vty-reference.pdf> <https://ftp.osmocom.org/docs/latest-osmotrx-usrp1-vty-reference.pdf>
- [37] [3gpp-ts-23-041] 3GPP TS 23.041: Technical realization of Cell Broadcast Service (CBS)
- [38] [3gpp-ts-23-048] 3GPP TS 23.048: Security mechanisms for the (U)SIM application toolkit; Stage 2 <https://www.3gpp.org/DynaReport/23048.htm>
- [39] [3gpp-ts-23-236] 3GPP TS 23.236: Intra-domain connection of Radio Access Network (RAN) nodes to multiple Core Network (CN) nodes <https://www.3gpp.org/DynaReport/23236.htm>
- [40] [3gpp-ts-24-007] 3GPP TS 24.007: Mobile radio interface signalling layer 3; General Aspects <https://www.3gpp.org/DynaReport/24007.htm>
- [41] [3gpp-ts-24-008] 3GPP TS 24.008: Mobile radio interface Layer 3 specification; Core network protocols; Stage 3. <https://www.3gpp.org/dynareport/24008.htm>
- [42] [3gpp-ts-31-101] 3GPP TS 31.101: UICC-terminal interface; Physical and logical characteristics <https://www.3gpp.org/DynaReport/31101.htm>
- [43] [3gpp-ts-31-102] 3GPP TS 31.102: Characteristics of the Universal Subscriber Identity Module (USIM) application <https://www.3gpp.org/DynaReport/31102.htm>
- [44] [3gpp-ts-31-103] 3GPP TS 31.103: Characteristics of the IMS Subscriber Identity Module (ISIM) application <https://www.3gpp.org/DynaReport/31103.htm>



- [45] [3gpp-ts-31-111] 3GPP TS 31.111: Universal Subscriber Identity Module (USIM) Application Toolkit (USAT) <https://www.3gpp.org/DynaReport/31111.htm>
- [46] [3gpp-ts-31-115] 3GPP TS 31.115: Secured packet structure for (Universal) Subscriber Identity Module (U)SIM Toolkit applications <https://www.3gpp.org/DynaReport/31115.htm>
- [47] [3gpp-ts-31-116] 3GPP TS 31.116: Remote APDU Structure for (U)SIM Toolkit applications <https://www.3gpp.org/DynaReport/31116.htm>
- [48] [3gpp-ts-35-205] 3GPP TS 35.205: 3G Security; Specification of the MILENAGE algorithm set: General
- [49] [3gpp-ts-35-206] 3GPP TS 35.206: 3G Security; Specification of the MILENAGE algorithm set: Algorithm specification <https://www.3gpp.org/DynaReport/35206.htm>
- [50] [3gpp-ts-44-006] 3GPP TS 44.006: Mobile Station - Base Station System (MS - BSS) interface; Data Link (DL) layer specification <https://www.3gpp.org/DynaReport/44006.htm>
- [51] [3gpp-ts-44-018] 3GPP TS 44.018: Mobile radio interface layer 3 specification; Radio Resource Control (RRC) protocol <https://www.3gpp.org/DynaReport/44018.htm>
- [52] [3gpp-ts-44-064] 3GPP TS 44.064: Mobile Station - Serving GPRS Support Node (MS-SGSN); Logical Link Control (LLC) Layer Specification <https://www.3gpp.org/DynaReport/44064.htm>
- [53] [3gpp-ts-45-002] 3GPP TS 45.002: Digital cellular telecommunications system (Phase 2+) (GSM); GSM/EDGE Multiplexing and multiple access on the radio path <https://www.3gpp.org/DynaReport/45002.htm>
- [54] [3gpp-ts-48-008] 3GPP TS 48.008: Mobile Switching Centre - Base Station system (MSC-BSS) interface; Layer 3 specification <https://www.3gpp.org/DynaReport/48008.htm>
- [55] [3gpp-ts-48-016] 3GPP TS 48.016: General Packet Radio Service (GPRS); Base Station System (BSS) - Serving GPRS Support Node (SGSN) interface; Network service <https://www.3gpp.org/DynaReport/48016.htm>
- [56] [3gpp-ts-48-018] 3GPP TS 48.018: General Packet Radio Service (GPRS); Base Station System (BSS) - Serving GPRS Support Node (SGSN); BSS GPRS protocol (BSSGP) <https://www.3gpp.org/DynaReport/48018.htm>
- [57] [3gpp-ts-48-049] 3GPP TS 48.049: Digital cellular communications system; Base Station Controller - Cell Broadcast Centre (BSC-CBC) interface specification; Cell Broadcast Service Protocol (CBSP) <https://www.3gpp.org/DynaReport/48049.htm>
- [58] [3gpp-ts-48-056] 3GPP TS 48.056: Base Station Controller - Base Transceiver Station (BSC - BTS) interface; Layer 2 specification <https://www.3gpp.org/DynaReport/48056.htm>
- [59] [3gpp-ts-48-058] 3GPP TS 48.058: Base Station Controller - Base Transceiver Station (BSC - BTS) Interface; Layer 3 specification <https://www.3gpp.org/DynaReport/48058.htm>
- [60] [3gpp-ts-51-011] 3GPP TS 51.011: Specification of the Subscriber Identity Module - Mobile Equipment (SIM-ME) interface
- [61] [3gpp-ts-51-014] 3GPP TS 51.014: Specification of the SIM Application Toolkit for the Subscriber Identity Module - Mobile Equipment (SIM - ME) interface <https://www.3gpp.org/DynaReport/51014.htm>
- [62] [3gpp-ts-52-021] 3GPP TS 52.021: Network Management (NM) procedures and messages on the A-bis interface <https://www.3gpp.org/DynaReport/52021.htm>
- [63] [etsi-tr102216] ETSI TR 102 216: Smart cards [https://www.etsi.org/deliver/etsi\\_tr/102200\\_102299/102216/-03.00.00\\_60/tr\\_102216v030000p.pdf](https://www.etsi.org/deliver/etsi_tr/102200_102299/102216/-03.00.00_60/tr_102216v030000p.pdf)
- [64] [etsi-ts102221] ETSI TS 102 221: Smart Cards; UICC-Terminal interface; Physical and logical characteristics [https://www.etsi.org/deliver/etsi\\_ts/102200\\_102299/102221/13.01.00\\_60/ts\\_102221v130100p.pdf](https://www.etsi.org/deliver/etsi_ts/102200_102299/102221/13.01.00_60/ts_102221v130100p.pdf)
- [65] [etsi-ts101220] ETSI TS 101 220: Smart Cards; ETSI numbering system for telecommunication application providers [https://www.etsi.org/deliver/etsi\\_ts/101200\\_101299/101220/12.00.00\\_60/ts\\_101220v120000p.pdf](https://www.etsi.org/deliver/etsi_ts/101200_101299/101220/12.00.00_60/ts_101220v120000p.pdf)
- [66] [ieee-802.1q] IEEE 802.1Q: Bridges and Bridged Networks <https://ieeexplore.ieee.org/document/6991462>

- [67] [ietf-rfc768] IETF RFC 768: User Datagram Protocol <https://tools.ietf.org/html/rfc768>
- [68] [ietf-rfc791] IETF RFC 791: Internet Protocol <https://tools.ietf.org/html/rfc791>
- [69] [ietf-rfc793] IETF RFC 793: Transmission Control Protocol <https://tools.ietf.org/html/rfc793>
- [70] [ietf-rfc1035] IETF RFC 1035: Domain Names - Implementation and Specification <https://tools.ietf.org/html/rfc1035>
- [71] [ietf-rfc1350] IETF RFC 1350: Trivial File Transfer Protocol <https://tools.ietf.org/html/rfc1350>
- [72] [ietf-rfc2131] IETF RFC 2131: Dynamic Host Configuration Protocol <https://tools.ietf.org/html/rfc2131>
- [73] [ietf-rfc2474] IETF RFC 2474: Definition of the Differentiated Services Field (DS Field) in the IPv4 and IPv6 Headers <https://tools.ietf.org/html/rfc2474>
- [74] [ietf-rfc2719] IETF RFC 2719: Signal Transport over IP <https://tools.ietf.org/html/rfc2719>
- [75] [ietf-rfc3331] IETF RFC 3331: Message Transfer Part 2 User Adaptation Layer <https://tools.ietf.org/html/rfc3331>
- [76] [ietf-rfc3550] IETF RFC 3550: RTP: A Transport protocol for Real-Time Applications <https://tools.ietf.org/html/rfc3550>
- [77] [ietf-rfc3596] IETF RFC 3596: DNS Extensions to Support IP Version 6 <https://tools.ietf.org/html/rfc3596>
- [78] [ietf-rfc3868] IETF RFC 3868: SCCP User Adaptation Layer <https://tools.ietf.org/html/rfc3868>
- [79] [ietf-rfc4165] IETF RFC 4165: Message Transfer Part 2 Peer-to-Peer Adaptation Layer <https://tools.ietf.org/html/rfc4165>
- [80] [ietf-rfc4251] IETF RFC 4251: The Secure Shell (SSH) Protocol Architecture <https://tools.ietf.org/html/rfc4251>
- [81] [ietf-rfc4666] IETF RFC 4666: Message Transfer Part 3 User Adaptation Layer <https://tools.ietf.org/html/rfc4666>
- [82] [ietf-rfc5771] IETF RFC 5771: IANA Guidelines for IPv4 Multicast Address Assignments <https://tools.ietf.org/html/rfc5771>
- [83] [itu-t-q701] ITU-T Q.701: Functional Description of the Message Transfer Part (MTP) <https://www.itu.int/rec/T-REC-Q.701/en/>
- [84] [itu-t-q711] ITU-T Q.711: Functional Description of the Signalling Connection Control Part <https://www.itu.int/rec/T-REC-Q.711/en/>
- [85] [itu-t-q713] ITU-T Q.713: Signalling connection control part formats and codes <https://www.itu.int/rec/T-REC-Q.713/en/>
- [86] [itu-t-q714] ITU-T Q.714: Signalling connection control part procedures <https://www.itu.int/rec/T-REC-Q.714/en/>
- [87] [itu-t-q921] ITU-T Q.921: ISDN user-network interface - Data link layer specification <https://www.itu.int/rec/T-REC-Q.921/en/>
- [88] [smpp-34] SMPP Developers Forum. Short Message Peer-to-Peer Protocol Specification v3.4 [https://docs.nimta.com/SMPP\\_v3\\_4\\_Issue1\\_2.pdf](https://docs.nimta.com/SMPP_v3_4_Issue1_2.pdf)
- [89] [gnu-agplv3] Free Software Foundation. GNU Affero General Public License. <https://www.gnu.org/licenses/agpl-3.0.en.html>
- [90] [freeswitch\_pbx] FreeSWITCH SIP PBX <https://freeswitch.org>

## C GNU Free Documentation License

Version 1.3, 3 November 2008

Copyright © 2000, 2001, 2002, 2007, 2008 Free Software Foundation, Inc. <http://fsf.org/>

Everyone is permitted to copy and distribute verbatim copies of this license document, but changing it is not allowed.

### C.1 PREAMBLE

The purpose of this License is to make a manual, textbook, or other functional and useful document “free” in the sense of freedom: to assure everyone the effective freedom to copy and redistribute it, with or without modifying it, either commercially or noncommercially. Secondly, this License preserves for the author and publisher a way to get credit for their work, while not being considered responsible for modifications made by others.

This License is a kind of “copyleft”, which means that derivative works of the document must themselves be free in the same sense. It complements the GNU General Public License, which is a copyleft license designed for free software.

We have designed this License in order to use it for manuals for free software, because free software needs free documentation: a free program should come with manuals providing the same freedoms that the software does. But this License is not limited to software manuals; it can be used for any textual work, regardless of subject matter or whether it is published as a printed book. We recommend this License principally for works whose purpose is instruction or reference.

### C.2 APPLICABILITY AND DEFINITIONS

This License applies to any manual or other work, in any medium, that contains a notice placed by the copyright holder saying it can be distributed under the terms of this License. Such a notice grants a world-wide, royalty-free license, unlimited in duration, to use that work under the conditions stated herein. The “Document”, below, refers to any such manual or work. Any member of the public is a licensee, and is addressed as “you”. You accept the license if you copy, modify or distribute the work in a way requiring permission under copyright law.

A “Modified Version” of the Document means any work containing the Document or a portion of it, either copied verbatim, or with modifications and/or translated into another language.

A “Secondary Section” is a named appendix or a front-matter section of the Document that deals exclusively with the relationship of the publishers or authors of the Document to the Document’s overall subject (or to related matters) and contains nothing that could fall directly within that overall subject. (Thus, if the Document is in part a textbook of mathematics, a [Secondary Section](#) may not explain any mathematics.) The relationship could be a matter of historical connection with the subject or with related matters, or of legal, commercial, philosophical, ethical or political position regarding them.

The “Invariant Sections” are certain [Secondary Section](#) whose titles are designated, as being those of [Invariant Sections](#), in the notice that says that the Document is released under this License. If a section does not fit the above definition of Secondary then it is not allowed to be designated as Invariant. The Document may contain zero [Invariant Sections](#). If the Document does not identify any Invariant Sections then there are none.

The “Cover Texts” are certain short passages of text that are listed, as Front-Cover Texts or Back-Cover Texts, in the notice that says that the Document is released under this License. A Front-Cover Text may be at most 5 words, and a Back-Cover Text may be at most 25 words.

A “Transparent” copy of the Document means a machine-readable copy, represented in a format whose specification is available to the general public, that is suitable for revising the document straightforwardly with generic text editors or (for images composed of pixels) generic paint programs or (for drawings) some widely available drawing editor, and that is suitable for input to text formatters or for automatic translation to a variety of formats suitable for input to text formatters. A copy made in an otherwise [Transparent](#) file format whose markup, or absence of markup, has been arranged to thwart or discourage subsequent modification by readers is not [Transparent](#). An image format is not [Transparent](#) if used for any substantial amount of text. A copy that is not [Transparent](#) is called “Opaque”.

Examples of suitable formats for [Transparent](#) copies include plain ASCII without markup, Texinfo input format, LaTeX input format, SGML or XML using a publicly available DTD, and standard-conforming simple HTML, PostScript or PDF designed for human modification. Examples of transparent image formats include PNG, XCF and JPG. Opaque formats include proprietary

formats that can be read and edited only by proprietary word processors, SGML or XML for which the DTD and/or processing tools are not generally available, and the machine-generated HTML, PostScript or PDF produced by some word processors for output purposes only.

The “Title Page” means, for a printed book, the title page itself, plus such following pages as are needed to hold, legibly, the material this License requires to appear in the title page. For works in formats which do not have any title page as such, [Title Page](#) means the text near the most prominent appearance of the work’s title, preceding the beginning of the body of the text.

The “publisher” means any person or entity that distributes copies of the Document to the public.

A section “Entitled XYZ” means a named subunit of the Document whose title either is precisely XYZ or contains XYZ in parentheses following text that translates XYZ in another language. (Here XYZ stands for a specific section name mentioned below, such as “Acknowledgements”, “Dedications”, “Endorsements”, or “History”.) To “Preserve the Title” of such a section when you modify the Document means that it remains a section “Entitled XYZ” according to this definition.

The Document may include Warranty Disclaimers next to the notice which states that this License applies to the Document. These Warranty Disclaimers are considered to be included by reference in this License, but only as regards disclaiming warranties: any other implication that these Warranty Disclaimers may have is void and has no effect on the meaning of this License.

### C.3 VERBATIM COPYING

You may copy and distribute the Document in any medium, either commercially or noncommercially, provided that this License, the copyright notices, and the license notice saying this License applies to the Document are reproduced in all copies, and that you add no other conditions whatsoever to those of this License. You may not use technical measures to obstruct or control the reading or further copying of the copies you make or distribute. However, you may accept compensation in exchange for copies. If you distribute a large enough number of copies you must also follow the conditions in section [Section C.4](#).

You may also lend copies, under the same conditions stated above, and you may publicly display copies.

### C.4 COPYING IN QUANTITY

If you publish printed copies (or copies in media that commonly have printed covers) of the Document, numbering more than 100, and the Document’s license notice requires [Cover Texts](#), you must enclose the copies in covers that carry, clearly and legibly, all these Cover Texts: [Front-Cover Texts](#) on the front cover, and [Back-Cover Texts](#) on the back cover. Both covers must also clearly and legibly identify you as the publisher of these copies. The front cover must present the full title with all words of the title equally prominent and visible. You may add other material on the covers in addition. Copying with changes limited to the covers, as long as they preserve the title of the Document and satisfy these conditions, can be treated as verbatim copying in other respects.

If the required texts for either cover are too voluminous to fit legibly, you should put the first ones listed (as many as fit reasonably) on the actual cover, and continue the rest onto adjacent pages.

If you publish or distribute Opaque copies of the Document numbering more than 100, you must either include a machine-readable [Transparent](#) copy along with each Opaque copy, or state in or with each Opaque copy a computer-network location from which the general network-using public has access to download using public-standard network protocols a complete [Transparent](#) copy of the Document, free of added material. If you use the latter option, you must take reasonably prudent steps, when you begin distribution of Opaque copies in quantity, to ensure that this [Transparent](#) copy will remain thus accessible at the stated location until at least one year after the last time you distribute an Opaque copy (directly or through your agents or retailers) of that edition to the public.

It is requested, but not required, that you contact the authors of the Document well before redistributing any large number of copies, to give them a chance to provide you with an updated version of the Document.

### C.5 MODIFICATIONS

You may copy and distribute a [Modified Version](#) of the Document under the conditions of sections 2 and 3 above, provided that you release the [Modified Version](#) under precisely this License, with the [Modified Version](#) filling the role of the Document, thus licensing distribution and modification of the [Modified Version](#) to whoever possesses a copy of it. In addition, you must do these things in the [Modified Version](#):

- a. Use in the [Title Page](#) (and on the covers, if any) a title distinct from that of the Document, and from those of previous versions (which should, if there were any, be listed in the History section of the Document). You may use the same title as a previous version if the original publisher of that version gives permission.
- b. List on the [Title Page](#), as authors, one or more persons or entities responsible for authorship of the modifications in the [Modified Version](#), together with at least five of the principal authors of the Document (all of its principal authors, if it has fewer than five), unless they release you from this requirement.
- c. State on the [Title Page](#) the name of the publisher of the [Modified Version](#), as the publisher.
- d. Preserve all the copyright notices of the Document.
- e. Add an appropriate copyright notice for your modifications adjacent to the other copyright notices.
- f. Include, immediately after the copyright notices, a license notice giving the public permission to use the [Modified Version](#) under the terms of this License, in the form shown in the Addendum below.
- g. Preserve in that license notice the full lists of [Invariant Sections](#) and required [Cover Texts](#) given in the Document's license notice.
- h. Include an unaltered copy of this License.
- i. Preserve the section Entitled "History", Preserve its Title, and add to it an item stating at least the title, year, new authors, and publisher of the [Modified Version](#) as given on the [Title Page](#). If there is no section Entitled "History" in the Document, create one stating the title, year, authors, and publisher of the Document as given on its [Title Page](#), then add an item describing the [Modified Version](#) as stated in the previous sentence.
- j. Preserve the network location, if any, given in the Document for public access to a [Transparent](#) copy of the Document, and likewise the network locations given in the Document for previous versions it was based on. These may be placed in the "History" section. You may omit a network location for a work that was published at least four years before the Document itself, or if the original publisher of the version it refers to gives permission.
- k. For any section Entitled "Acknowledgements" or "Dedications", Preserve the Title of the section, and preserve in the section all the substance and tone of each of the contributor acknowledgements and/or dedications given therein.
- l. Preserve all the [Invariant Sections](#) of the Document, unaltered in their text and in their titles. Section numbers or the equivalent are not considered part of the section titles.
- m. Delete any section Entitled "Endorsements". Such a section may not be included in the [Modified Version](#).
- n. Do not retitle any existing section to be Entitled "Endorsements" or to conflict in title with any [Invariant Sections](#).
- o. Preserve any Warranty Disclaimers.

If the [Modified Version](#) includes new front-matter sections or appendices that qualify as [Secondary Section](#) and contain no material copied from the Document, you may at your option designate some or all of these sections as invariant. To do this, add their titles to the list of [Invariant Sections](#) in the [Modified Version](#)'s license notice. These titles must be distinct from any other section titles.

You may add a section Entitled "Endorsements", provided it contains nothing but endorsements of your [Modified Version](#) by various parties—for example, statements of peer review or that the text has been approved by an organization as the authoritative definition of a standard.

You may add a passage of up to five words as a Front-Cover Text, and a passage of up to 25 words as a Back-Cover Text, to the end of the list of [Cover Texts](#) in the [Modified Version](#). Only one passage of Front-Cover Text and one of Back-Cover Text may be added by (or through arrangements made by) any one entity. If the Document already includes a cover text for the same cover, previously added by you or by arrangement made by the same entity you are acting on behalf of, you may not add another; but you may replace the old one, on explicit permission from the previous publisher that added the old one.

The author(s) and publisher(s) of the Document do not by this License give permission to use their names for publicity for or to assert or imply endorsement of any [Modified Version](#).

## C.6 COMBINING DOCUMENTS

You may combine the Document with other documents released under this License, under the terms defined in section 4 above for modified versions, provided that you include in the combination all of the [Invariant Sections](#) of all of the original documents, unmodified, and list them all as [Invariant Sections](#) of your combined work in its license notice, and that you preserve all their Warranty Disclaimers.

The combined work need only contain one copy of this License, and multiple identical [Invariant Sections](#) may be replaced with a single copy. If there are multiple [Invariant Sections](#) with the same name but different contents, make the title of each such section unique by adding at the end of it, in parentheses, the name of the original author or publisher of that section if known, or else a unique number. Make the same adjustment to the section titles in the list of [Invariant Sections](#) in the license notice of the combined work.

In the combination, you must combine any sections Entitled “History” in the various original documents, forming one section Entitled “History”; likewise combine any sections Entitled “Acknowledgements”, and any sections Entitled “Dedications”. You must delete all sections Entitled “Endorsements”.

## C.7 COLLECTIONS OF DOCUMENTS

You may make a collection consisting of the Document and other documents released under this License, and replace the individual copies of this License in the various documents with a single copy that is included in the collection, provided that you follow the rules of this License for verbatim copying of each of the documents in all other respects.

You may extract a single document from such a collection, and distribute it individually under this License, provided you insert a copy of this License into the extracted document, and follow this License in all other respects regarding verbatim copying of that document.

## C.8 AGGREGATION WITH INDEPENDENT WORKS

A compilation of the Document or its derivatives with other separate and independent documents or works, in or on a volume of a storage or distribution medium, is called an “aggregate” if the copyright resulting from the compilation is not used to limit the legal rights of the compilation’s users beyond what the individual works permit. When the Document is included in an aggregate, this License does not apply to the other works in the aggregate which are not themselves derivative works of the Document.

If the Cover Text requirement of section 3 is applicable to these copies of the Document, then if the Document is less than one half of the entire aggregate, the Document’s [Cover Texts](#) may be placed on covers that bracket the Document within the aggregate, or the electronic equivalent of covers if the Document is in electronic form. Otherwise they must appear on printed covers that bracket the whole aggregate.

## C.9 TRANSLATION

Translation is considered a kind of modification, so you may distribute translations of the Document under the terms of section 4. Replacing [Invariant Sections](#) with translations requires special permission from their copyright holders, but you may include translations of some or all [Invariant Sections](#) in addition to the original versions of these [Invariant Sections](#). You may include a translation of this License, and all the license notices in the Document, and any Warranty Disclaimers, provided that you also include the original English version of this License and the original versions of those notices and disclaimers. In case of a disagreement between the translation and the original version of this License or a notice or disclaimer, the original version will prevail.

If a section in the Document is Entitled “Acknowledgements”, “Dedications”, or “History”, the requirement (section 4) to Preserve its Title (section 1) will typically require changing the actual title.

## C.10 TERMINATION

You may not copy, modify, sublicense, or distribute the Document except as expressly provided under this License. Any attempt otherwise to copy, modify, sublicense, or distribute it is void, and will automatically terminate your rights under this License.

However, if you cease all violation of this License, then your license from a particular copyright holder is reinstated (a) provisionally, unless and until the copyright holder explicitly and finally terminates your license, and (b) permanently, if the copyright holder fails to notify you of the violation by some reasonable means prior to 60 days after the cessation.

Moreover, your license from a particular copyright holder is reinstated permanently if the copyright holder notifies you of the violation by some reasonable means, this is the first time you have received notice of violation of this License (for any work) from that copyright holder, and you cure the violation prior to 30 days after your receipt of the notice.

Termination of your rights under this section does not terminate the licenses of parties who have received copies or rights from you under this License. If your rights have been terminated and not permanently reinstated, receipt of a copy of some or all of the same material does not give you any rights to use it.

## C.11 FUTURE REVISIONS OF THIS LICENSE

The Free Software Foundation may publish new, revised versions of the GNU Free Documentation License from time to time. Such new versions will be similar in spirit to the present version, but may differ in detail to address new problems or concerns. See <http://www.gnu.org/copyleft/>.

Each version of the License is given a distinguishing version number. If the Document specifies that a particular numbered version of this License “or any later version” applies to it, you have the option of following the terms and conditions either of that specified version or of any later version that has been published (not as a draft) by the Free Software Foundation. If the Document does not specify a version number of this License, you may choose any version ever published (not as a draft) by the Free Software Foundation. If the Document specifies that a proxy can decide which future versions of this License can be used, that proxy’s public statement of acceptance of a version permanently authorizes you to choose that version for the Document.

## C.12 RELICENSING

“Massive Multiauthor Collaboration Site” (or “MMC Site”) means any World Wide Web server that publishes copyrightable works and also provides prominent facilities for anybody to edit those works. A public wiki that anybody can edit is an example of such a server. A “Massive Multiauthor Collaboration” (or “MMC”) contained in the site means any set of copyrightable works thus published on the MMC site.

“CC-BY-SA” means the Creative Commons Attribution-Share Alike 3.0 license published by Creative Commons Corporation, a not-for-profit corporation with a principal place of business in San Francisco, California, as well as future copyleft versions of that license published by that same organization.

“Incorporate” means to publish or republish a Document, in whole or in part, as part of another Document.

An MMC is “eligible for relicensing” if it is licensed under this License, and if all works that were first published under this License somewhere other than this MMC, and subsequently incorporated in whole or in part into the MMC, (1) had no cover texts or invariant sections, and (2) were thus incorporated prior to November 1, 2008.

The operator of an MMC Site may republish an MMC contained in the site under CC-BY-SA on the same site at any time before August 1, 2009, provided the MMC is eligible for relicensing.

## C.13 ADDENDUM: How to use this License for your documents

To use this License in a document you have written, include a copy of the License in the document and put the following copyright and license notices just after the title page:

```
Copyright (c) YEAR YOUR NAME.
Permission is granted to copy, distribute and/or modify this document
under the terms of the GNU Free Documentation License, Version 1.3
or any later version published by the Free Software Foundation;
with no Invariant Sections, no Front-Cover Texts, and no Back-Cover Texts.
A copy of the license is included in the section entitled ``GNU
Free Documentation License''.
```

If you have [Invariant Sections](#), [Front-Cover Texts](#) and [Back-Cover Texts](#), replace the “with... Texts.” line with this:

with the Invariant Sections being LIST THEIR TITLES, with the Front-Cover Texts being LIST, and with the Back-Cover Texts being LIST.

If you have [Invariant Sections](#) without [Cover Texts](#), or some other combination of the three, merge those two alternatives to suit the situation.

If your document contains nontrivial examples of program code, we recommend releasing these examples in parallel under your choice of free software license, such as the GNU General Public License, to permit their use in free software.